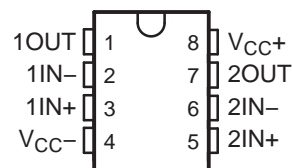

DUAL GENERAL-PURPOSE OPERATIONAL AMPLIFIER

 Check for Samples: [RC4558](#)

FEATURES

- Continuous Short-Circuit Protection
- Wide Common-Mode and Differential Voltage Ranges
- No Frequency Compensation Required
- Low Power Consumption
- No Latch-Up
- Unity-Gain Bandwidth . . . 3 MHz Typ
- Gain and Phase Match Between Amplifiers
- Low Noise . . . 8 nV/√Hz Typ at 1 kHz

 D, DGK, P, PS, OR PW PACKAGE
(TOP VIEW)

DESCRIPTION/ORDERING INFORMATION

The RC4558 device is a dual general-purpose operational amplifier, with each half electrically similar to the μ A741, except that offset null capability is not provided.

The high common-mode input voltage range and the absence of latch-up make this amplifier ideal for voltage-follower applications. The device is short-circuit protected, and the internal frequency compensation ensures stability without external components.

Table 1. ORDERING INFORMATION

T _A	PACKAGE ⁽¹⁾		ORDERABLE PART NUMBER	TOP-SIDE MARKING
0°C to 70°C	MSOP/VSSOP – DGK	Reel of 2500	RC4558DGKR	YR ₋ ⁽²⁾
	PDIP – P	Tube of 50	RC4558P	RC4558P
	SOIC – D	Tube of 75	RC4558D	RC4558
		Reel of 2500	RC4558DRG3	
	SOP – PS	Reel of 2000	RC4558PSR	R4558
	TSSOP – PW	Tube of 150	RC4558PW	R4558
Reel of 2000		RC4558PWR		
–40°C to 85°C	MSOP/VSSOP – DGK	Reel of 2500	RC4558IDGKR	YS ₋ ⁽²⁾
	PDIP – P	Tube of 50	RC4558IP	RC4558IP
	SOIC – D	Tube of 75	RC4558ID	R4558I
		Reel of 2500	RC4558IDR	
	TSSOP – PW	Tube of 150	RC4558IPW	R4558I
		Reel of 2000	RC4558IPWR	

(1) Package drawings, standard packing quantities, thermal data, symbolization, and PCB design guidelines are available at www.ti.com/sc/package.

(2) The actual top-side marking has one additional character that designates the assembly/test site.



Please be aware that an important notice concerning availability, standard warranty, and use in critical applications of Texas Instruments semiconductor products and disclaimers thereto appears at the end of this data sheet.

Absolute Maximum Ratings⁽¹⁾

over operating free-air temperature range (unless otherwise noted)

		MIN	MAX	UNIT
V _{CC+}	Supply voltage ⁽²⁾		18	V
V _{CC-}			-18	
V _{ID}	Differential input voltage ⁽³⁾		±30	V
V _I	Input voltage (any input) ^{(2) (4)}		±15	V
Duration of output short circuit to ground, one amplifier at a time ⁽⁵⁾			Unlimited	
θ _{JA}	Package thermal impedance ^{(6) (7)}	D package	97	°C/W
		DGK package	172	
		P package	85	
		PS package	95	
		PW package	149	
T _J	Operating virtual junction temperature		150	°C
T _{stg}	Storage temperature range	-65	150	°C

- (1) Stresses beyond those listed under *Absolute Maximum Ratings* may cause permanent damage to the device. These are stress ratings only, and functional operation of the device at these or any other conditions beyond those indicated under *Recommended Operating Conditions* is not implied. Exposure to absolute-maximum-rated conditions for extended periods may affect device reliability.
- (2) All voltage values, unless otherwise noted, are with respect to the midpoint between V_{CC+} and V_{CC-}.
- (3) Differential voltages are at IN+ with respect to IN-.
- (4) The magnitude of the input voltage must never exceed the magnitude of the supply voltage or 15 V, whichever is less.
- (5) Temperature and/or supply voltages must be limited to ensure that the dissipation rating is not exceeded.
- (6) Maximum power dissipation is a function of T_J (max), θ_{JA}, and T_A. The maximum allowable power dissipation at any allowable ambient temperature is P_D = (T_J (max) – T_A)/θ_{JA}. Operating at the absolute maximum T_J of 150°C can affect reliability.
- (7) The package thermal impedance is calculated in accordance with JESD 51-7.

Recommended Operating Conditions

		MIN	MAX	UNIT	
V _{CC+}	Supply voltage	5	15	V	
V _{CC-}		-5	-15		
T _A	Operating free-air temperature	RC4558	0	70	°C
		RC4558I	-40	85	

Electrical Characteristics

at specified free-air temperature, $V_{CC+} = 15\text{ V}$, $V_{CC-} = -15\text{ V}$

PARAMETER		TEST CONDITIONS ⁽¹⁾	T_A ⁽²⁾	MIN	TYP	MAX	UNIT
V_{IO}	Input offset voltage	$V_O = 0$	25°C		0.5	6	mV
			Full range			7.5	
I_{IO}	Input offset current	$V_O = 0$	25°C		5	200	nA
			Full range			300	
I_{IB}	Input bias current	$V_O = 0$	25°C		150	500	nA
			Full range			800	
V_{ICR}	Common-mode input voltage range		25°C	±12	±14		V
V_{OM}	Maximum output voltage swing	$R_L = 10\text{ k}\Omega$	25°C	±12	±14		V
			Full range	±10			
		$R_L = 2\text{ k}\Omega$	Full range	±10			
A_{VD}	Large-signal differential voltage amplification	$R_L \geq 2\text{ k}\Omega$, $V_O = \pm 10\text{ V}$	25°C	20	300		V/mV
			Full range	15			
B_1	Unity-gain bandwidth		25°C		3		MHz
r_i	Input resistance		25°C	0.3	5		M Ω
CMRR	Common-mode rejection ratio		25°C	70	90		dB
k_{SVS}	Supply-voltage sensitivity ($\Delta V_{IO}/\Delta V_{CC}$)	$V_{CC} = \pm 15\text{ V}$ to $\pm 9\text{ V}$	25°C		30	150	$\mu\text{V/V}$
V_n	Equivalent input noise voltage (closed loop)	$A_{VD} = 100$, $R_S = 100\ \Omega$, $f = 1\text{ kHz}$, $BW = 1\text{ Hz}$	25°C		8		$\text{nV}/\sqrt{\text{Hz}}$
I_{CC}	Supply current (both amplifiers)	$V_O = 0$, No load	25°C		2.5	5.6	mA
			T_A min		3	6.6	
			T_A max		2.3	5	
P_D	Total power dissipation (both amplifiers)	$V_O = 0$, No load	25°C		75	170	mW
			T_A min		90	200	
			T_A max		70	150	
V_{O1}/V_{O2}	Crosstalk attenuation	Open loop	25°C		85		dB
		$A_{VD} = 100$		$R_S = 1\text{ k}\Omega$, $f = 10\text{ kHz}$		105	

(1) All characteristics are measured under open-loop conditions with zero common-mode input voltage, unless otherwise specified.

(2) Full range is 0°C to 70°C for RC4558 and -40°C to 85°C for RC4558I.

Operating Characteristics

$V_{CC+} = 15\text{ V}$, $V_{CC-} = -15\text{ V}$, $T_A = 25^\circ\text{C}$

PARAMETER		TEST CONDITIONS			MIN	TYP	MAX	UNIT
t_r	Rise time	$V_I = 20\text{ mV}$,	$R_L = 2\text{ k}\Omega$,	$C_L = 100\text{ pF}$		0.13		ns
	Overshoot	$V_I = 20\text{ mV}$,	$R_L = 2\text{ k}\Omega$,	$C_L = 100\text{ pF}$		5		%
SR	Slew rate at unity gain	$V_I = 10\text{ V}$,	$R_L = 2\text{ k}\Omega$,	$C_L = 100\text{ pF}$	1.1	1.7		V/ μs

TYPICAL CHARACTERISTICS

SUPPLY CURRENT
vs
SUPPLY VOLTAGE
($T_A = 25^\circ\text{C}$)

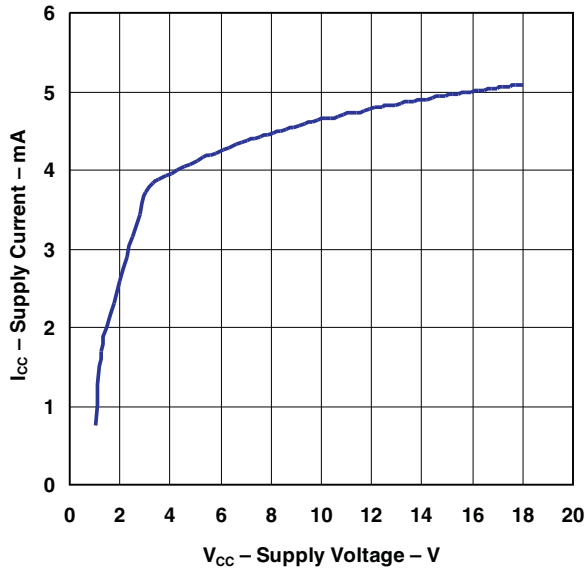

SUPPLY CURRENT
vs
TEMPERATURE
($V_{CC} = \pm 15\text{ V}$)

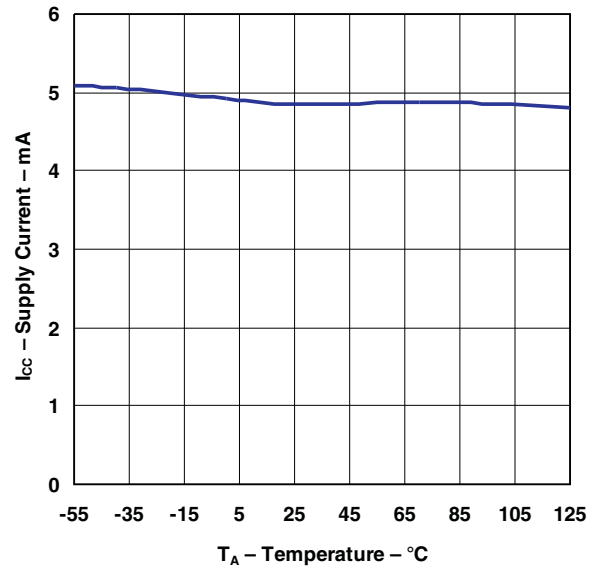

GAIN AND PHASE
vs
FREQUENCY
($V_{CC} = \pm 15\text{ V}$, $R_L = 2\text{ k}\Omega$, $C_L = 22\text{ pF}$)

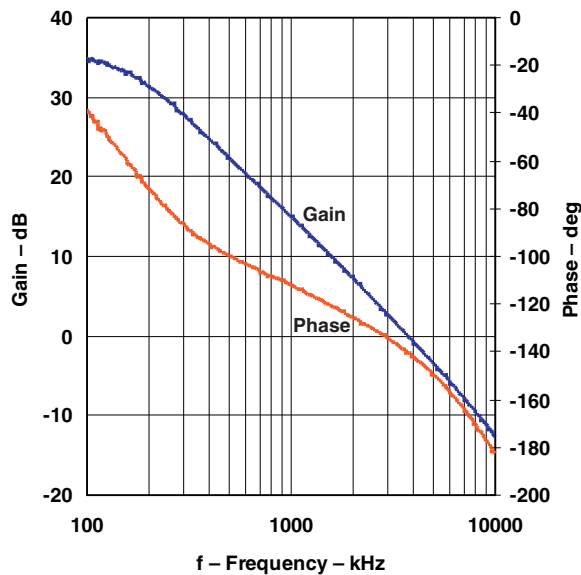

GAIN AND PHASE
vs
FREQUENCY
($V_{CC} = \pm 15\text{ V}$, $R_L = 10\text{ k}\Omega$, $C_L = 22\text{ pF}$)

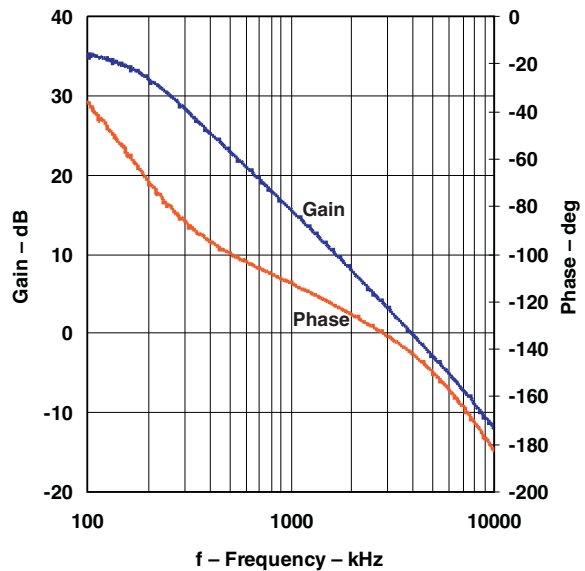

TYPICAL CHARACTERISTICS (continued)

OUTPUT VOLTAGE SWING
vs
SUPPLY VOLTAGE
($R_L = 2\text{ k}\Omega$, $T_A = 25^\circ\text{C}$)

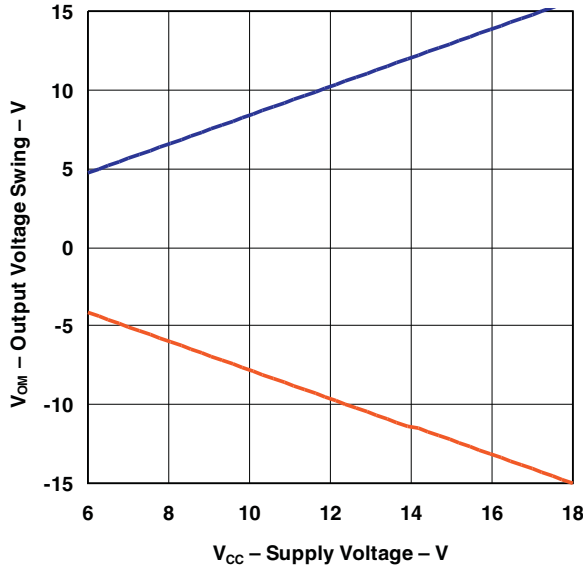

OUTPUT VOLTAGE SWING
vs
FREQUENCY
($V_{CC} = \pm 15\text{ V}$, $R_L = 2\text{ k}\Omega$, $T_A = 25^\circ\text{C}$)

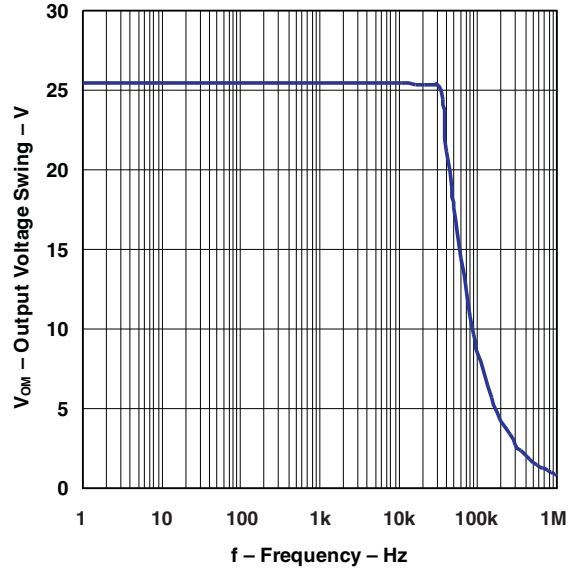

OUTPUT VOLTAGE SWING
vs
LOAD RESISTANCE
($V_{CC} = \pm 15\text{ V}$, $T_A = 25^\circ\text{C}$)

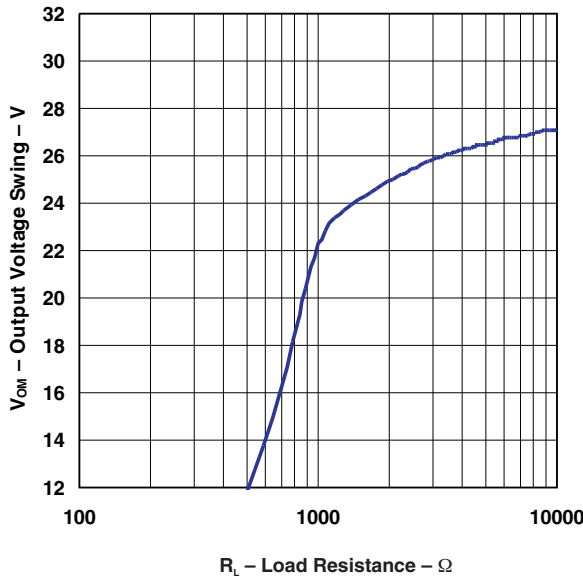

OUTPUT VOLTAGE SWING
vs
TEMPERATURE
($V_{CC} = \pm 15\text{ V}$, $R_L = 10\text{ k}\Omega$)

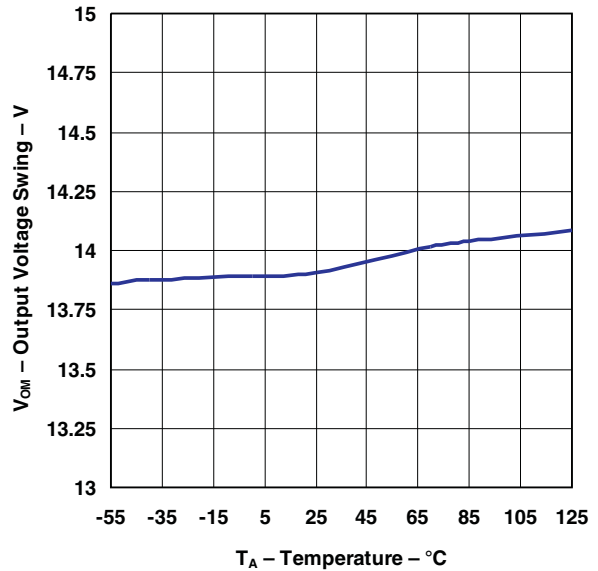

TYPICAL CHARACTERISTICS (continued)

NEGATIVE OUTPUT VOLTAGE SWING
vs
TEMPERATURE
($V_{CC} = \pm 15\text{ V}$, $R_L = 10\text{ k}\Omega$)

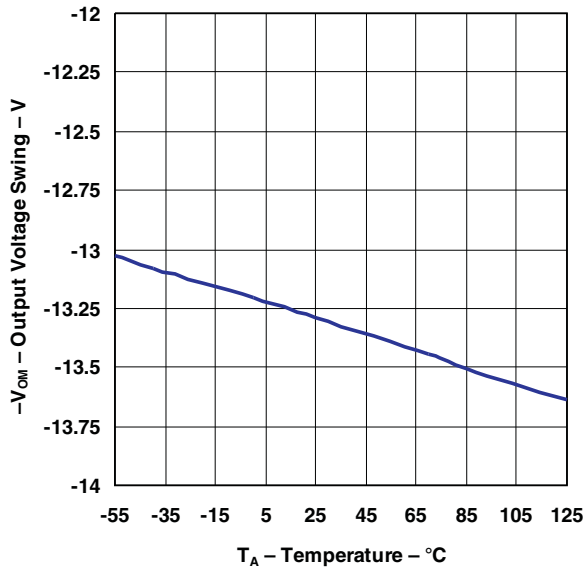

OPEN LOOP GAIN
vs
FREQUENCY
($V_{CC} = \pm 15\text{ V}$, $R_L = 2\text{ k}\Omega$, $C_L = 22\text{ pF}$, $T_A = 25^\circ\text{C}$)

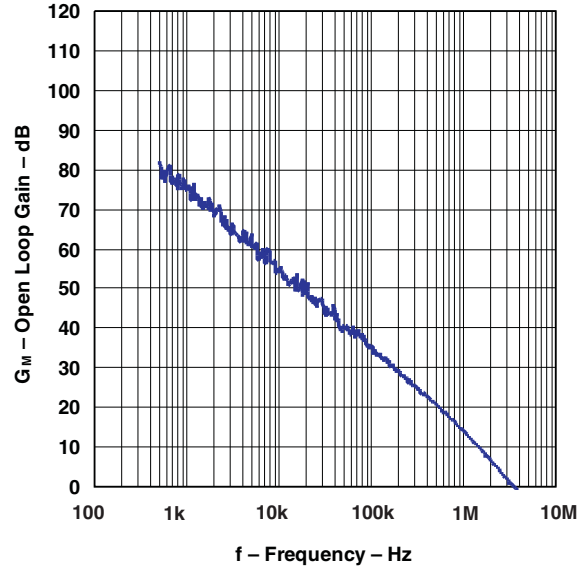

INPUT BIAS CURRENT
vs
TEMPERATURE
($V_{CC} = \pm 15\text{ V}$)

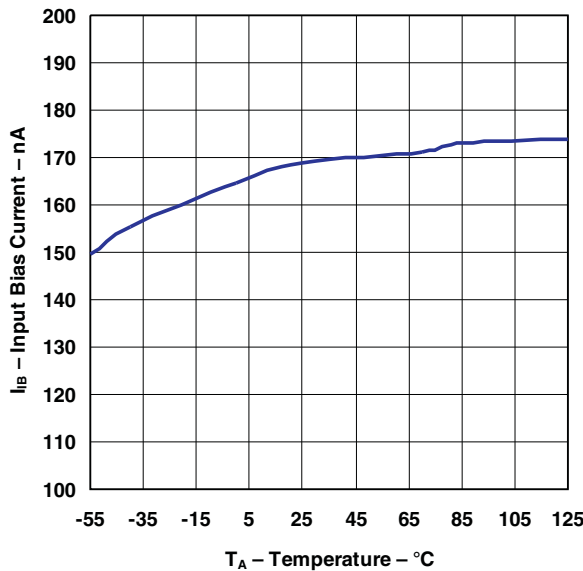

INPUT OFFSET VOLTAGE
vs
TEMPERATURE
($V_{CC} = \pm 15\text{ V}$)

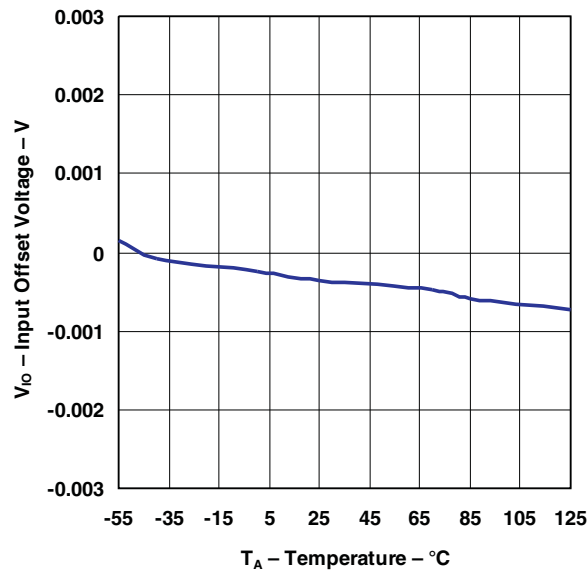

TYPICAL CHARACTERISTICS (continued)

INPUT NOISE VOLTAGE

vs

FREQUENCY

($V_{CC} = \pm 15\text{ V}$, $T_A = 25^\circ\text{C}$)

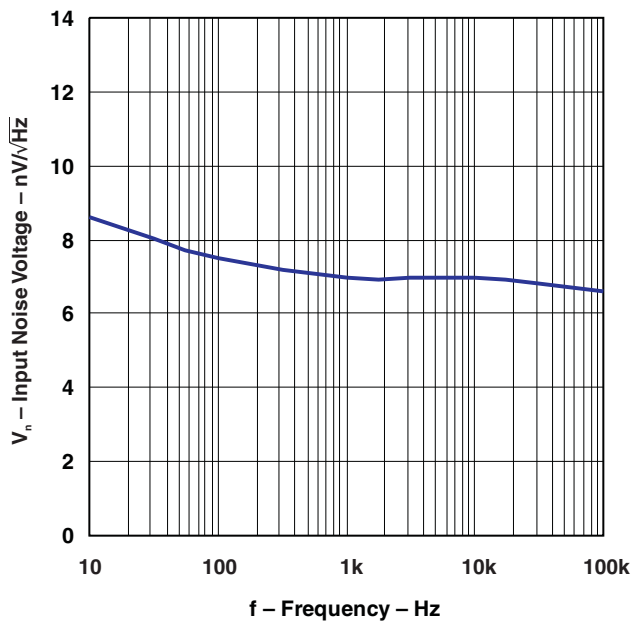

PACKAGING INFORMATION

Orderable Device	Status (1)	Package Type	Package Drawing	Pins	Package Qty	Eco Plan (2)	Lead/Ball Finish (6)	MSL Peak Temp (3)	Op Temp (°C)	Device Marking (4/5)	Samples
RC4558-W	ACTIVE	WAFERSALE	YS	0		TBD	Call TI	Call TI			Samples
RC4558D	ACTIVE	SOIC	D	8	75	Green (RoHS & no Sb/Br)	CU NIPDAU	Level-1-260C-UNLIM	0 to 70	RC4558	Samples
RC4558DE4	ACTIVE	SOIC	D	8	75	Green (RoHS & no Sb/Br)	CU NIPDAU	Level-1-260C-UNLIM	0 to 70	RC4558	Samples
RC4558DG4	ACTIVE	SOIC	D	8	75	Green (RoHS & no Sb/Br)	CU NIPDAU	Level-1-260C-UNLIM	0 to 70	RC4558	Samples
RC4558DGKR	ACTIVE	VSSOP	DGK	8	2500	Green (RoHS & no Sb/Br)	CU NIPDAU CU NIPDAUAG	Level-1-260C-UNLIM	0 to 70	(YRP ~ YRS ~ YRU)	Samples
RC4558DGKRG4	ACTIVE	VSSOP	DGK	8	2500	Green (RoHS & no Sb/Br)	CU NIPDAU	Level-1-260C-UNLIM	0 to 70	(YRP ~ YRS ~ YRU)	Samples
RC4558DR	ACTIVE	SOIC	D	8	2500	Green (RoHS & no Sb/Br)	CU NIPDAU CU SN	Level-1-260C-UNLIM	0 to 70	RC4558	Samples
RC4558DRE4	ACTIVE	SOIC	D	8		TBD	Call TI	Call TI	0 to 70		Samples
RC4558DRG3	ACTIVE	SOIC	D	8	2500	Green (RoHS & no Sb/Br)	CU SN	Level-1-260C-UNLIM	0 to 70	RC4558	Samples
RC4558DRG4	ACTIVE	SOIC	D	8	2500	Green (RoHS & no Sb/Br)	CU NIPDAU	Level-1-260C-UNLIM	0 to 70	RC4558	Samples
RC4558ID	ACTIVE	SOIC	D	8	75	Green (RoHS & no Sb/Br)	CU NIPDAU	Level-1-260C-UNLIM	-40 to 85	R4558I	Samples
RC4558IDE4	ACTIVE	SOIC	D	8		TBD	Call TI	Call TI	-40 to 85		Samples
RC4558IDG4	ACTIVE	SOIC	D	8		TBD	Call TI	Call TI	-40 to 85		Samples
RC4558IDGKR	ACTIVE	VSSOP	DGK	8	2500	Green (RoHS & no Sb/Br)	CU NIPDAU CU NIPDAUAG	Level-1-260C-UNLIM	-40 to 85	(YSP ~ YSS ~ YSU)	Samples
RC4558IDGKRG4	ACTIVE	VSSOP	DGK	8	2500	Green (RoHS & no Sb/Br)	CU NIPDAU	Level-1-260C-UNLIM	-40 to 85	(YSP ~ YSS ~ YSU)	Samples
RC4558IDR	ACTIVE	SOIC	D	8	2500	Green (RoHS & no Sb/Br)	CU NIPDAU	Level-1-260C-UNLIM	-40 to 85	R4558I	Samples
RC4558IDRE4	ACTIVE	SOIC	D	8		TBD	Call TI	Call TI	-40 to 85		Samples
RC4558IDRG4	ACTIVE	SOIC	D	8	2500	Green (RoHS & no Sb/Br)	CU NIPDAU	Level-1-260C-UNLIM	-40 to 85	R4558I	Samples

Orderable Device	Status (1)	Package Type	Package Drawing	Pins	Package Qty	Eco Plan (2)	Lead/Ball Finish (6)	MSL Peak Temp (3)	Op Temp (°C)	Device Marking (4/5)	Samples
RC4558IP	ACTIVE	PDIP	P	8	50	Pb-Free (RoHS)	CU NIPDAU	N / A for Pkg Type	-40 to 85	RC4558IP	Samples
RC4558IPE4	ACTIVE	PDIP	P	8	50	Pb-Free (RoHS)	CU NIPDAU	N / A for Pkg Type	-40 to 85	RC4558IP	Samples
RC4558IPW	ACTIVE	TSSOP	PW	8	150	Green (RoHS & no Sb/Br)	CU NIPDAU	Level-1-260C-UNLIM	-40 to 85	R4558I	Samples
RC4558IPWE4	ACTIVE	TSSOP	PW	8		TBD	Call TI	Call TI	-40 to 85		Samples
RC4558IPWG4	ACTIVE	TSSOP	PW	8		TBD	Call TI	Call TI	-40 to 85		Samples
RC4558IPWR	ACTIVE	TSSOP	PW	8	2000	Green (RoHS & no Sb/Br)	CU NIPDAU CU SN	Level-1-260C-UNLIM	-40 to 85	R4558I	Samples
RC4558IPWRE4	ACTIVE	TSSOP	PW	8		TBD	Call TI	Call TI	-40 to 85		Samples
RC4558IPWRG4	OBSOLETE	TSSOP	PW	8		TBD	Call TI	Call TI	-40 to 85		
RC4558P	ACTIVE	PDIP	P	8	50	Pb-Free (RoHS)	CU NIPDAU	N / A for Pkg Type	0 to 70	RC4558P	Samples
RC4558PE4	ACTIVE	PDIP	P	8	50	Pb-Free (RoHS)	CU NIPDAU	N / A for Pkg Type	0 to 70	RC4558P	Samples
RC4558PSLE	OBSOLETE	SO	PS	8		TBD	Call TI	Call TI	0 to 70		
RC4558PSR	ACTIVE	SO	PS	8	2000	Green (RoHS & no Sb/Br)	CU NIPDAU	Level-1-260C-UNLIM	0 to 70	R4558	Samples
RC4558PSRE4	ACTIVE	SO	PS	8		TBD	Call TI	Call TI	0 to 70		Samples
RC4558PSRG4	ACTIVE	SO	PS	8	2000	Green (RoHS & no Sb/Br)	CU NIPDAU	Level-1-260C-UNLIM	0 to 70	R4558	Samples
RC4558PW	ACTIVE	TSSOP	PW	8	150	Green (RoHS & no Sb/Br)	CU NIPDAU	Level-1-260C-UNLIM	0 to 70	R4558	Samples
RC4558PWE4	ACTIVE	TSSOP	PW	8		TBD	Call TI	Call TI	0 to 70		Samples
RC4558PWG4	ACTIVE	TSSOP	PW	8		TBD	Call TI	Call TI	0 to 70		Samples
RC4558PWLE	OBSOLETE	TSSOP	PW	8		TBD	Call TI	Call TI	0 to 70		
RC4558PWR	ACTIVE	TSSOP	PW	8	2000	Green (RoHS & no Sb/Br)	CU NIPDAU CU SN	Level-1-260C-UNLIM	0 to 70	R4558	Samples
RC4558PWRE4	ACTIVE	TSSOP	PW	8		TBD	Call TI	Call TI	0 to 70		Samples
RC4558PWRG4	OBSOLETE	TSSOP	PW	8		TBD	Call TI	Call TI	0 to 70		

Orderable Device	Status (1)	Package Type	Package Drawing	Pins	Package Qty	Eco Plan (2)	Lead/Ball Finish (6)	MSL Peak Temp (3)	Op Temp (°C)	Device Marking (4/5)	Samples
RC4558Y	OBSOLETE	DIESALE	Y	0		TBD	Call TI	Call TI			

(1) The marketing status values are defined as follows:

ACTIVE: Product device recommended for new designs.

LIFEBUY: TI has announced that the device will be discontinued, and a lifetime-buy period is in effect.

NRND: Not recommended for new designs. Device is in production to support existing customers, but TI does not recommend using this part in a new design.

PREVIEW: Device has been announced but is not in production. Samples may or may not be available.

OBSOLETE: TI has discontinued the production of the device.

(2) Eco Plan - The planned eco-friendly classification: Pb-Free (RoHS), Pb-Free (RoHS Exempt), or Green (RoHS & no Sb/Br) - please check <http://www.ti.com/productcontent> for the latest availability information and additional product content details.

TBD: The Pb-Free/Green conversion plan has not been defined.

Pb-Free (RoHS): TI's terms "Lead-Free" or "Pb-Free" mean semiconductor products that are compatible with the current RoHS requirements for all 6 substances, including the requirement that lead not exceed 0.1% by weight in homogeneous materials. Where designed to be soldered at high temperatures, TI Pb-Free products are suitable for use in specified lead-free processes.

Pb-Free (RoHS Exempt): This component has a RoHS exemption for either 1) lead-based flip-chip solder bumps used between the die and package, or 2) lead-based die adhesive used between the die and leadframe. The component is otherwise considered Pb-Free (RoHS compatible) as defined above.

Green (RoHS & no Sb/Br): TI defines "Green" to mean Pb-Free (RoHS compatible), and free of Bromine (Br) and Antimony (Sb) based flame retardants (Br or Sb do not exceed 0.1% by weight in homogeneous material)

(3) MSL, Peak Temp. - The Moisture Sensitivity Level rating according to the JEDEC industry standard classifications, and peak solder temperature.

(4) There may be additional marking, which relates to the logo, the lot trace code information, or the environmental category on the device.

(5) Multiple Device Markings will be inside parentheses. Only one Device Marking contained in parentheses and separated by a "~" will appear on a device. If a line is indented then it is a continuation of the previous line and the two combined represent the entire Device Marking for that device.

(6) Lead/Ball Finish - Orderable Devices may have multiple material finish options. Finish options are separated by a vertical ruled line. Lead/Ball Finish values may wrap to two lines if the finish value exceeds the maximum column width.

Important Information and Disclaimer: The information provided on this page represents TI's knowledge and belief as of the date that it is provided. TI bases its knowledge and belief on information provided by third parties, and makes no representation or warranty as to the accuracy of such information. Efforts are underway to better integrate information from third parties. TI has taken and continues to take reasonable steps to provide representative and accurate information but may not have conducted destructive testing or chemical analysis on incoming materials and chemicals. TI and TI suppliers consider certain information to be proprietary, and thus CAS numbers and other limited information may not be available for release.

In no event shall TI's liability arising out of such information exceed the total purchase price of the TI part(s) at issue in this document sold by TI to Customer on an annual basis.

TAPE AND REEL INFORMATION

QUADRANT ASSIGNMENTS FOR PIN 1 ORIENTATION IN TAPE

*All dimensions are nominal

Device	Package Type	Package Drawing	Pins	SPQ	Reel Diameter (mm)	Reel Width W1 (mm)	A0 (mm)	B0 (mm)	K0 (mm)	P1 (mm)	W (mm)	Pin1 Quadrant
RC4558DGKR	VSSOP	DGK	8	2500	330.0	12.4	5.3	3.4	1.4	8.0	12.0	Q1
RC4558DR	SOIC	D	8	2500	330.0	12.4	6.4	5.2	2.1	8.0	12.0	Q1
RC4558DR	SOIC	D	8	2500	330.0	12.4	6.4	5.2	2.1	8.0	12.0	Q1
RC4558DR	SOIC	D	8	2500	330.0	12.8	6.4	5.2	2.1	8.0	12.0	Q1
RC4558DRG3	SOIC	D	8	2500	330.0	12.8	6.4	5.2	2.1	8.0	12.0	Q1
RC4558DRG4	SOIC	D	8	2500	330.0	12.4	6.4	5.2	2.1	8.0	12.0	Q1
RC4558DRG4	SOIC	D	8	2500	330.0	12.4	6.4	5.2	2.1	8.0	12.0	Q1
RC4558IDGKR	VSSOP	DGK	8	2500	330.0	12.4	5.3	3.4	1.4	8.0	12.0	Q1
RC4558IDR	SOIC	D	8	2500	330.0	12.4	6.4	5.2	2.1	8.0	12.0	Q1
RC4558IPWR	TSSOP	PW	8	2000	330.0	12.4	7.0	3.6	1.6	8.0	12.0	Q1
RC4558IPWR	TSSOP	PW	8	2000	330.0	12.4	7.0	3.6	1.6	8.0	12.0	Q1
RC4558PSR	SO	PS	8	2000	330.0	16.4	8.2	6.6	2.5	12.0	16.0	Q1
RC4558PWR	TSSOP	PW	8	2000	330.0	12.4	7.0	3.6	1.6	8.0	12.0	Q1

TAPE AND REEL BOX DIMENSIONS

*All dimensions are nominal

Device	Package Type	Package Drawing	Pins	SPQ	Length (mm)	Width (mm)	Height (mm)
RC4558DGKR	VSSOP	DGK	8	2500	364.0	364.0	27.0
RC4558DR	SOIC	D	8	2500	367.0	367.0	35.0
RC4558DR	SOIC	D	8	2500	340.5	338.1	20.6
RC4558DR	SOIC	D	8	2500	364.0	364.0	27.0
RC4558DRG3	SOIC	D	8	2500	364.0	364.0	27.0
RC4558DRG4	SOIC	D	8	2500	367.0	367.0	35.0
RC4558DRG4	SOIC	D	8	2500	340.5	338.1	20.6
RC4558IDGKR	VSSOP	DGK	8	2500	364.0	364.0	27.0
RC4558IDR	SOIC	D	8	2500	340.5	338.1	20.6
RC4558IPWR	TSSOP	PW	8	2000	367.0	367.0	35.0
RC4558IPWR	TSSOP	PW	8	2000	364.0	364.0	27.0
RC4558PSR	SO	PS	8	2000	367.0	367.0	38.0
RC4558PWR	TSSOP	PW	8	2000	364.0	364.0	27.0

P (R-PDIP-T8)

PLASTIC DUAL-IN-LINE PACKAGE



- NOTES:
- A. All linear dimensions are in inches (millimeters).
 - B. This drawing is subject to change without notice.
 - C. Falls within JEDEC MS-001 variation BA.



- NOTES:
- A. All linear dimensions are in millimeters.
 - B. This drawing is subject to change without notice.
 - C. Publication IPC-7351 is recommended for alternate designs.
 - D. Laser cutting apertures with trapezoidal walls and also rounding corners will offer better paste release. Customers should contact their board assembly site for stencil design recommendations. Refer to IPC-7525 for other stencil recommendations.
 - E. Customers should contact their board fabrication site for solder mask tolerances between and around signal pads.

D (R-PDSO-G8)

PLASTIC SMALL OUTLINE



NOTES: A. All linear dimensions are in inches (millimeters).
 B. This drawing is subject to change without notice.
 C. Body length does not include mold flash, protrusions, or gate burrs. Mold flash, protrusions, or gate burrs shall not exceed 0.006 (0,15) each side.
 D. Body width does not include interlead flash. Interlead flash shall not exceed 0.017 (0,43) each side.
 E. Reference JEDEC MS-012 variation AA.

D (R-PDSO-G8)

PLASTIC SMALL OUTLINE



- NOTES:
- All linear dimensions are in millimeters.
 - This drawing is subject to change without notice.
 - Publication IPC-7351 is recommended for alternate designs.
 - Laser cutting apertures with trapezoidal walls and also rounding corners will offer better paste release. Customers should contact their board assembly site for stencil design recommendations. Refer to IPC-7525 for other stencil recommendations.
 - Customers should contact their board fabrication site for solder mask tolerances between and around signal pads.

MECHANICAL DATA

PS (R-PDSO-G8)

PLASTIC SMALL-OUTLINE PACKAGE



- NOTES:
- A. All linear dimensions are in millimeters.
 - B. This drawing is subject to change without notice.
 - C. Body dimensions do not include mold flash or protrusion, not to exceed 0,15.

PS (R-PDSO-G8)

PLASTIC SMALL OUTLINE



- NOTES:
- All linear dimensions are in millimeters.
 - This drawing is subject to change without notice.
 - Publication IPC-7351 is recommended for alternate designs.
 - Laser cutting apertures with trapezoidal walls and also rounding corners will offer better paste release. Customers should contact their board assembly site for stencil design recommendations. Refer to IPC-7525 for other stencil recommendations.
 - Customers should contact their board fabrication site for solder mask tolerances between and around signal pads.

PW (R-PDSO-G8)

PLASTIC SMALL OUTLINE

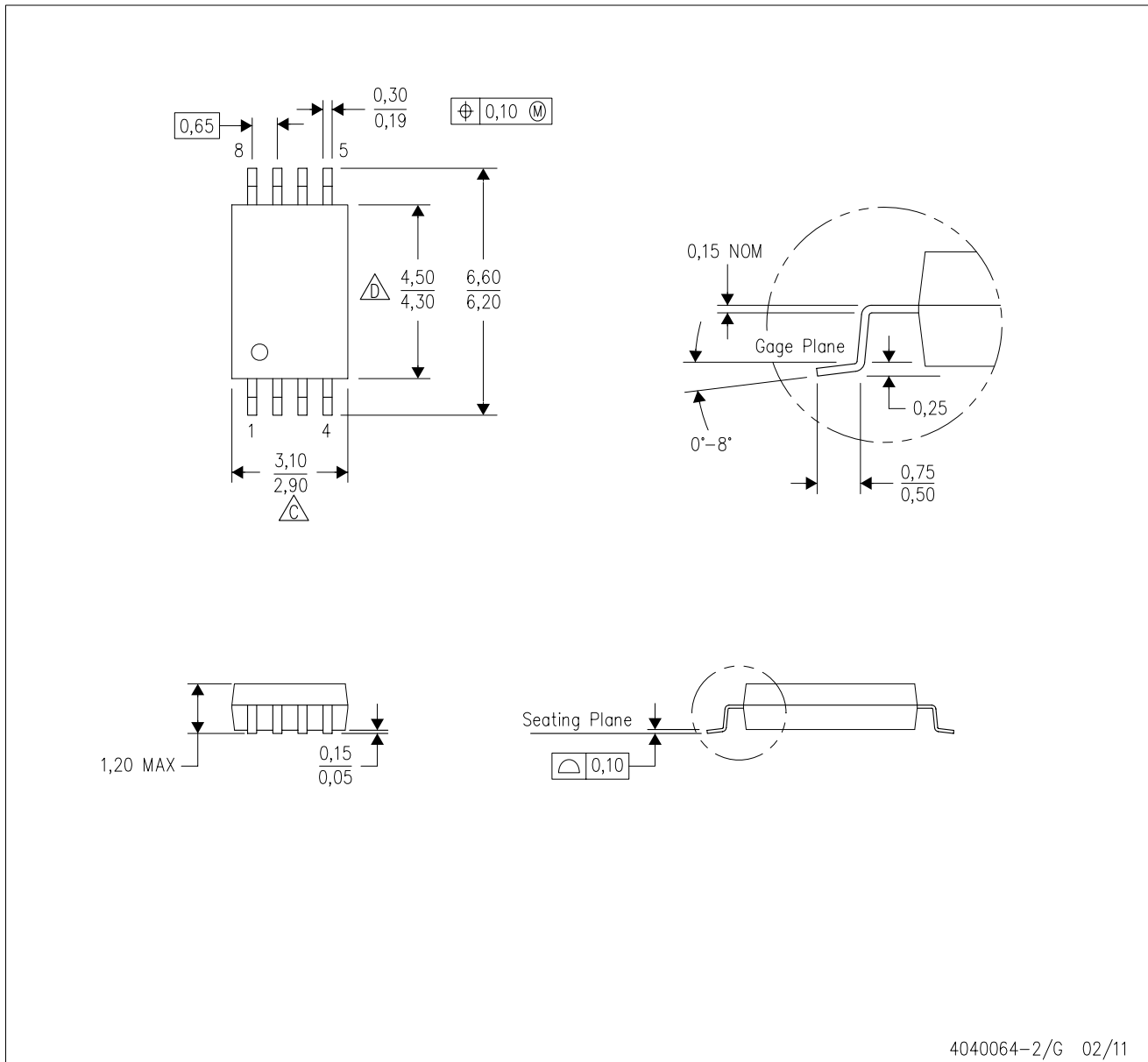

- NOTES:
- A. All linear dimensions are in millimeters. Dimensioning and tolerancing per ASME Y14.5M-1994.
 - B. This drawing is subject to change without notice.
 -  C. Body length does not include mold flash, protrusions, or gate burrs. Mold flash, protrusions, or gate burrs shall not exceed 0,15 each side.
 -  D. Body width does not include interlead flash. Interlead flash shall not exceed 0,25 each side.
 - E. Falls within JEDEC MO-153

IMPORTANT NOTICE

Texas Instruments Incorporated and its subsidiaries (TI) reserve the right to make corrections, enhancements, improvements and other changes to its semiconductor products and services per JESD46, latest issue, and to discontinue any product or service per JESD48, latest issue. Buyers should obtain the latest relevant information before placing orders and should verify that such information is current and complete. All semiconductor products (also referred to herein as "components") are sold subject to TI's terms and conditions of sale supplied at the time of order acknowledgment.

TI warrants performance of its components to the specifications applicable at the time of sale, in accordance with the warranty in TI's terms and conditions of sale of semiconductor products. Testing and other quality control techniques are used to the extent TI deems necessary to support this warranty. Except where mandated by applicable law, testing of all parameters of each component is not necessarily performed.

TI assumes no liability for applications assistance or the design of Buyers' products. Buyers are responsible for their products and applications using TI components. To minimize the risks associated with Buyers' products and applications, Buyers should provide adequate design and operating safeguards.

TI does not warrant or represent that any license, either express or implied, is granted under any patent right, copyright, mask work right, or other intellectual property right relating to any combination, machine, or process in which TI components or services are used. Information published by TI regarding third-party products or services does not constitute a license to use such products or services or a warranty or endorsement thereof. Use of such information may require a license from a third party under the patents or other intellectual property of the third party, or a license from TI under the patents or other intellectual property of TI.

Reproduction of significant portions of TI information in TI data books or data sheets is permissible only if reproduction is without alteration and is accompanied by all associated warranties, conditions, limitations, and notices. TI is not responsible or liable for such altered documentation. Information of third parties may be subject to additional restrictions.

Resale of TI components or services with statements different from or beyond the parameters stated by TI for that component or service voids all express and any implied warranties for the associated TI component or service and is an unfair and deceptive business practice. TI is not responsible or liable for any such statements.

Buyer acknowledges and agrees that it is solely responsible for compliance with all legal, regulatory and safety-related requirements concerning its products, and any use of TI components in its applications, notwithstanding any applications-related information or support that may be provided by TI. Buyer represents and agrees that it has all the necessary expertise to create and implement safeguards which anticipate dangerous consequences of failures, monitor failures and their consequences, lessen the likelihood of failures that might cause harm and take appropriate remedial actions. Buyer will fully indemnify TI and its representatives against any damages arising out of the use of any TI components in safety-critical applications.

In some cases, TI components may be promoted specifically to facilitate safety-related applications. With such components, TI's goal is to help enable customers to design and create their own end-product solutions that meet applicable functional safety standards and requirements. Nonetheless, such components are subject to these terms.

No TI components are authorized for use in FDA Class III (or similar life-critical medical equipment) unless authorized officers of the parties have executed a special agreement specifically governing such use.

Only those TI components which TI has specifically designated as military grade or "enhanced plastic" are designed and intended for use in military/aerospace applications or environments. Buyer acknowledges and agrees that any military or aerospace use of TI components which have **not** been so designated is solely at the Buyer's risk, and that Buyer is solely responsible for compliance with all legal and regulatory requirements in connection with such use.

TI has specifically designated certain components as meeting ISO/TS16949 requirements, mainly for automotive use. In any case of use of non-designated products, TI will not be responsible for any failure to meet ISO/TS16949.

Products

Audio	www.ti.com/audio
Amplifiers	amplifier.ti.com
Data Converters	dataconverter.ti.com
DLP® Products	www.dlp.com
DSP	dsp.ti.com
Clocks and Timers	www.ti.com/clocks
Interface	interface.ti.com
Logic	logic.ti.com
Power Mgmt	power.ti.com
Microcontrollers	microcontroller.ti.com
RFID	www.ti-rfid.com
OMAP Applications Processors	www.ti.com/omap
Wireless Connectivity	www.ti.com/wirelessconnectivity

Applications

Automotive and Transportation	www.ti.com/automotive
Communications and Telecom	www.ti.com/communications
Computers and Peripherals	www.ti.com/computers
Consumer Electronics	www.ti.com/consumer-apps
Energy and Lighting	www.ti.com/energy
Industrial	www.ti.com/industrial
Medical	www.ti.com/medical
Security	www.ti.com/security
Space, Avionics and Defense	www.ti.com/space-avionics-defense
Video and Imaging	www.ti.com/video

TI E2E Community

e2e.ti.com