

# Computer Networks

Lesson 1: Computer networks and Internet



# Lesson 1: Computer networks and Internet

## Objectives

- Contact and terminology
- Greater depth, details later in the course
- Focus: Use the Internet as an example

## Content

1. What is the Internet?
2. What is a protocol?
3. The network frontier: computers, access networks, physical media
4. The core of the network: packet/circuit switching, Internet architecture
5. Performance: losses, delays, transfer rate
6. Protocol layers, service models

# What is the Internet?

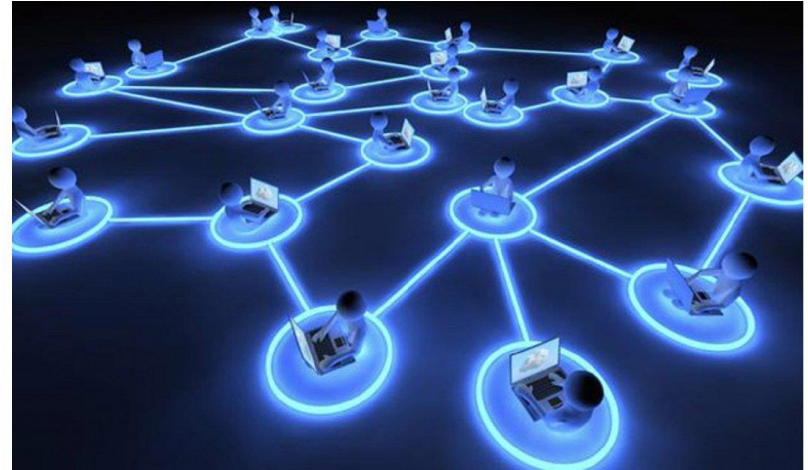

# What is the Internet?

## Hardware and Software

- Millions of connected computing devices: hosts, terminal systems
- Running network applications
- Network links

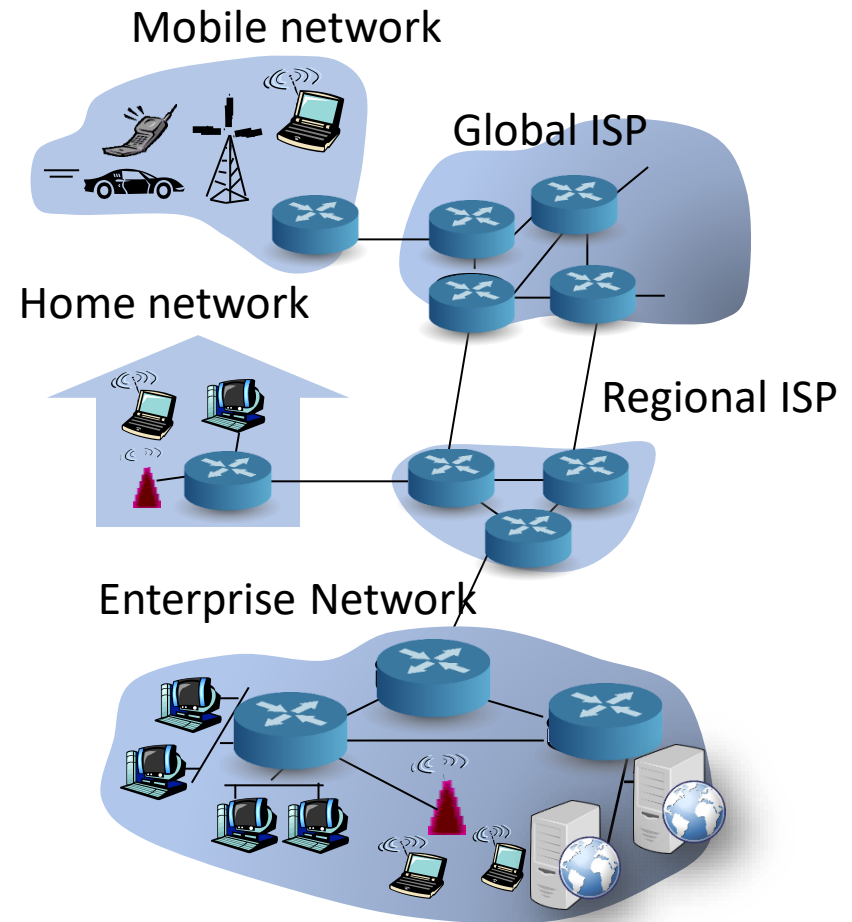

**ISP = Internet Service Provider**

# What is the Internet?

## Hardware and Software

- Protocols control sending and receiving of information.  
Examples: TCP, IP, HTTP, Skype, Ethernet
- Internet: it is the "network of networks"
  - Not very hierarchical
  - Public Internet vs. Private Intranet
- Internet Standards
  - RFC: Request for comments
  - IETF: Internet Engineering Task Force

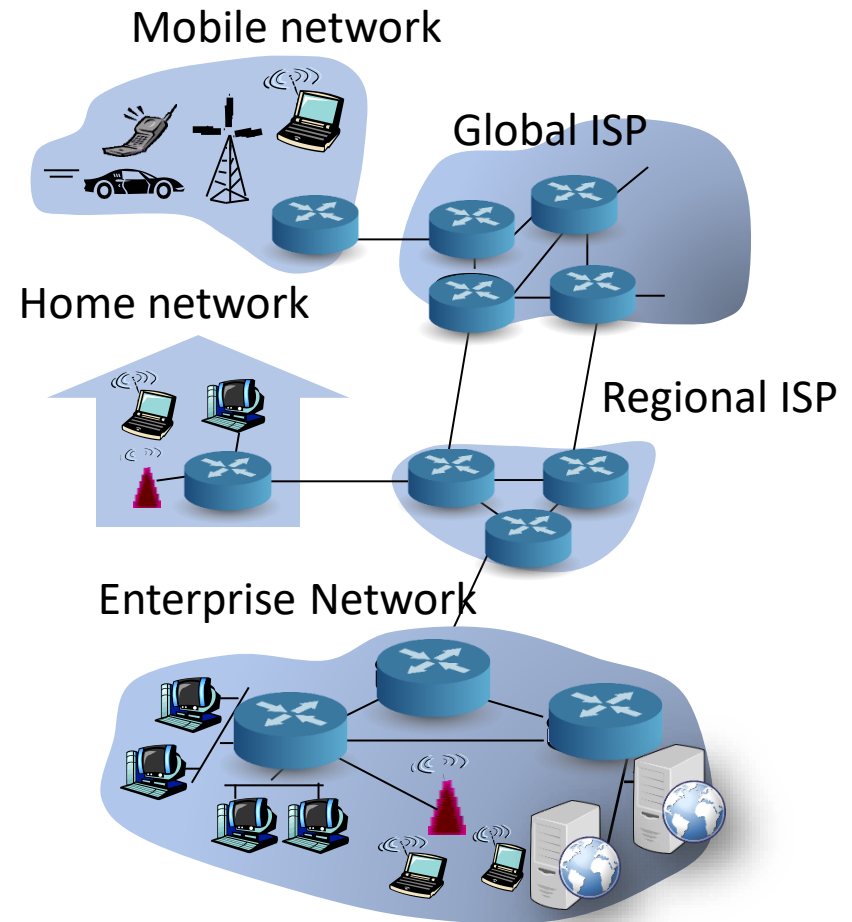

**ISP = Internet Service Provider**

# What is the Internet? Services

- **Communication infrastructure** enables distributed applications:
- Web, VoIP, mail and e-commerce, games, file sharing, Facebook, Twitter, Spotify...
- **Communication services** provided to applications:
  - Reliable source-to-destination data delivery
  - "Best effort" (unreliable) data delivery

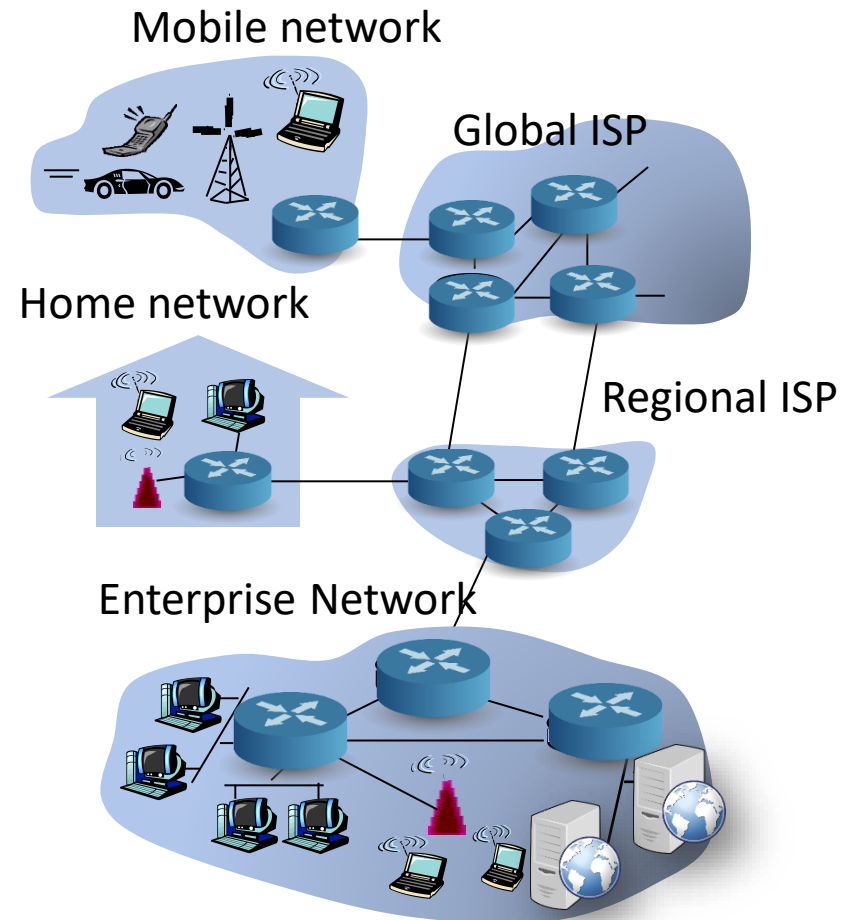

**ISP = Internet Service Provider**

# Lesson 1: Computer networks and Internet

## Objectives

- Contact and terminology
- Greater depth, details later in the course
- Focus: Use the Internet as an example

## Content

1. What is the Internet?
- 2. What is a protocol?**
3. The network frontier: computers, access networks, physical media
4. The core of the network: packet/circuit switching, Internet architecture
5. Performance: losses, delays, transfer rate
6. Protocol layers, service models

# What is a protocol?

## Human protocols

- Ask the current time
- Raise your hand
- Let out before entering
- ... specific messages are sent
- ... specific actions are taken when responses or other events are received

## Network protocols

- Machines are involved instead of human beings
- All communication activity on the Internet is governed by protocols

A protocol defines the format and order of messages sent and received between network entities, and the actions taken in transmitting and/or receiving a message or other event.



# What is a protocol?

## Human protocols

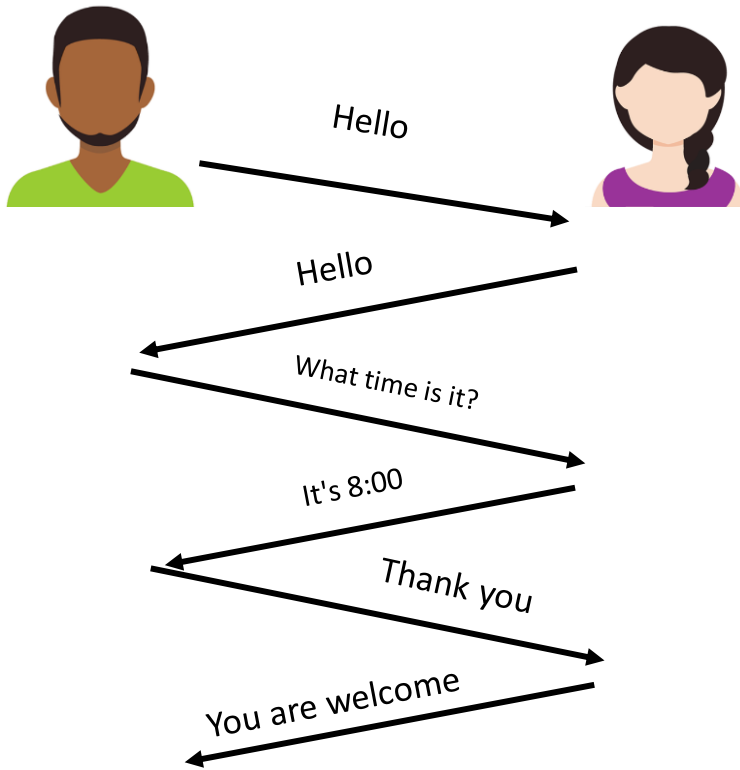

## Network protocols

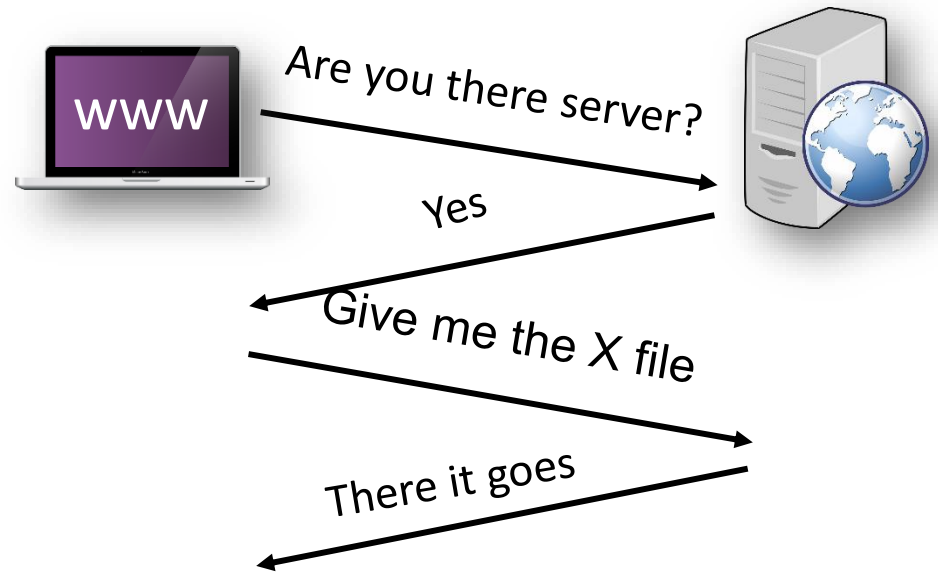

# What is a protocol?

## Human protocols

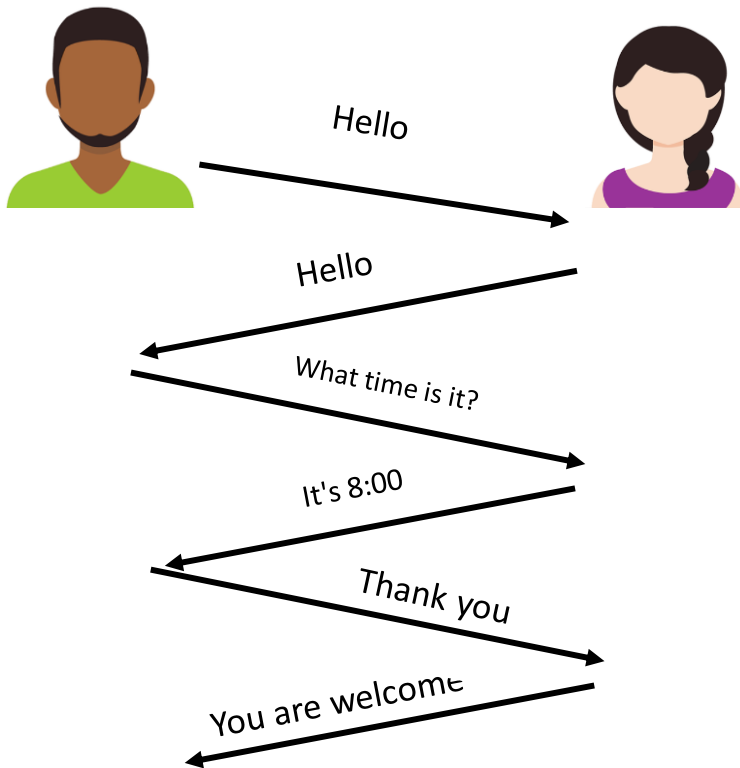

## Network protocols

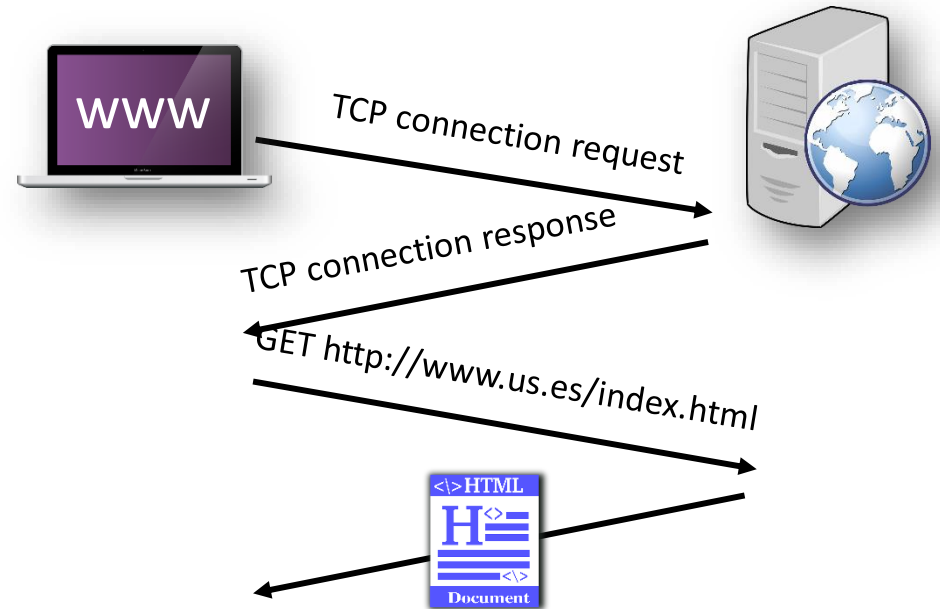

# Lesson 1: Computer networks and Internet

## Objectives

- Contact and terminology
- Greater depth, details later in the course
- Focus: Use the Internet as an example

## Content

1. What is the Internet?
2. What is a protocol?
3. **The network frontier: computers, access networks, physical media**
4. The core of the network: packet/circuit switching, Internet architecture
5. Performance: losses, delays, transfer rate
6. Protocol layers, service models

# Detailed overview of the Network Structure

- **The frontier of the network:** applications and terminal systems.
- **Access networks, physical media:** wired and wireless communication links.
- **The core of the network:**
  - interconnected routers
  - network of networks

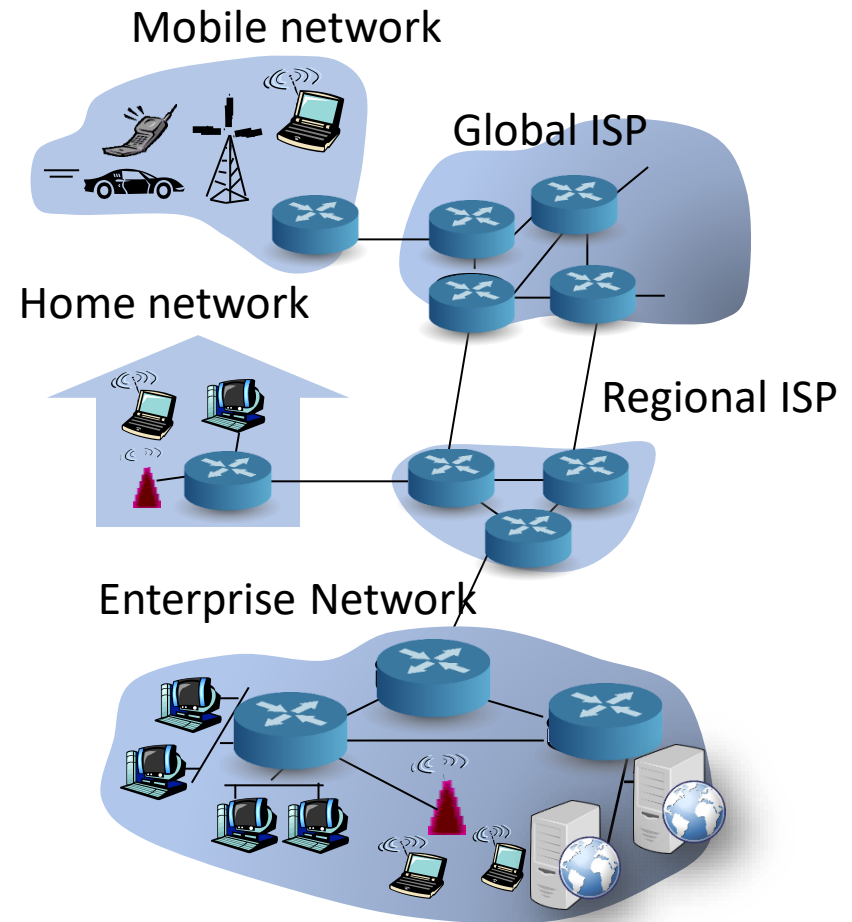

**ISP = Internet Service Provider**

# Network structure: The frontier of the network

- **Terminal systems (hosts):**
  - Run application programs
  - E.g. Web, email...
  - On the “frontier of the network”
- **Client/server model**
  - Client terminal system requests and receives a service from a server
  - e.g. browser/web server...
- **Peer-peer model:**
  - Minimal (or no) use of dedicated servers
  - e.g. Skype, BitTorrent...

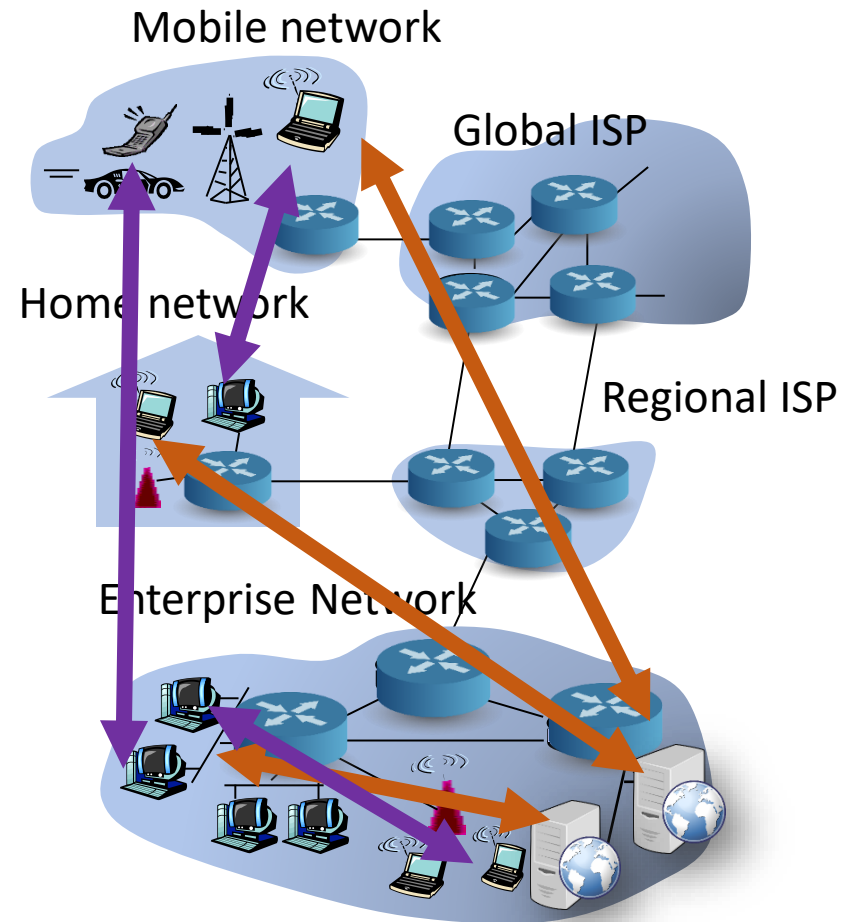

# Network Structure:

## Access networks and physical media

### How to connect terminal systems to a border router?

#### Home access networks

- Institutional access networks (school, company)
- Mobile access networks

#### Please note:

- Network access bandwidth (bits per second)
- Shared or dedicated
- Physical medium of transmission

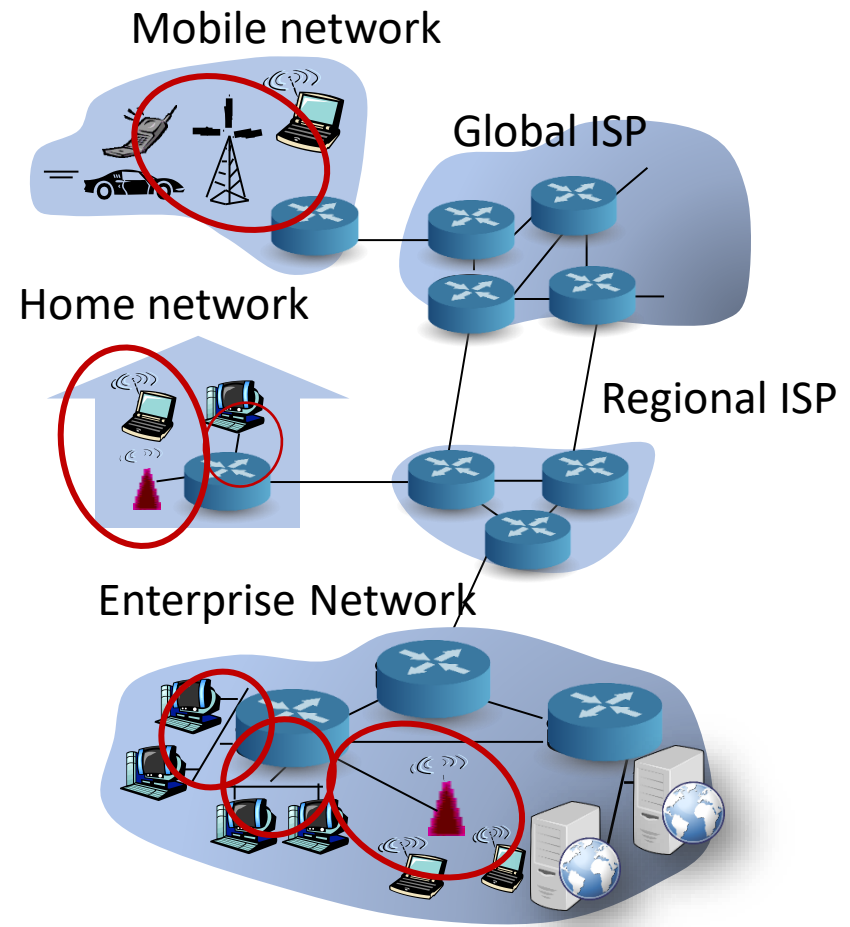

# Network Structure:

## Physical media

- Bit: propagates between pairs of transmitters and receivers
- Physical link: the medium between the transmitter and the receiver
  - Guided: signals are transported by a solid medium: copper (twisted pair; coaxial), fiber
  - Unguided: Signals propagate through space: terrestrial microwaves, WLAN (WiFi), mobile (4G), satellite

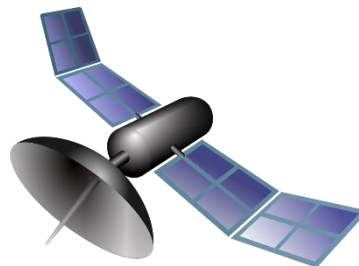

Twisted pair  
(UTP)

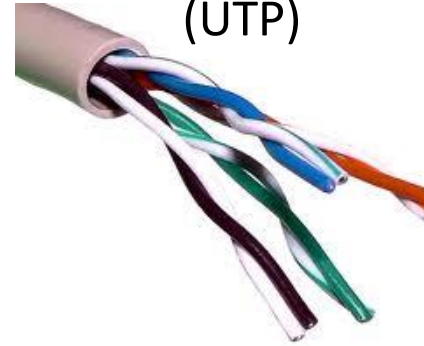

Coaxial

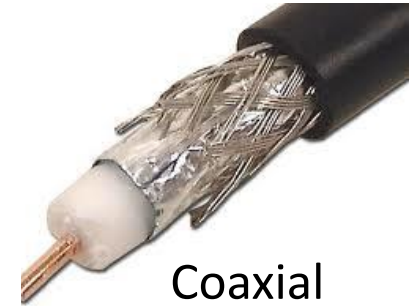

Optic fiber

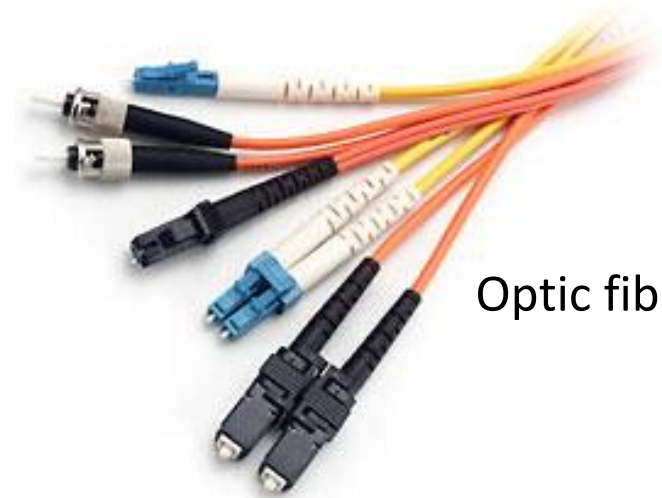

# Network Structure:

## Guided physical media

### Twisted Pair (TP)

- two insulated copper cables
- Cable Category => Supported Speed

### Coaxial cable:

- two concentric copper conductors
- bidirectional

### Optic fiber cable:

- fiberglass driving pulses of light, each pulse represents one bit
- High operating speed:
  - high-speed point-to-point transmission (e.g., 10's-100's Gpbs)
- low error rate: low attenuation allows widely spaced repeaters; immune to electromagnetic interference

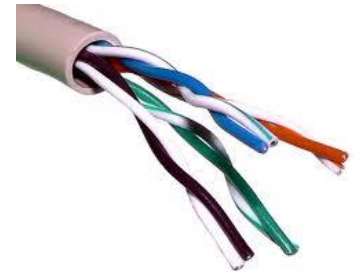
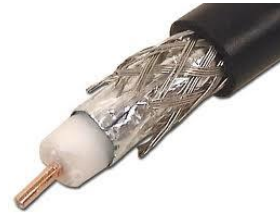



# Network Structure:

## Unguided physical media

- ❖ signals carried in the electromagnetic spectrum
- ❖ no physical "cable"
- ❖ Omnidirectional or directional.
- ❖ propagation environment effects:
  - reflection
  - object obstruction
  - interference

## Types of radio channels:

- ❖ terrestrial microwave
  - High directionality.
  - ❖ WLAN (e.g., WiFi)
    - Omnidirectional.
- ❖ area-wide (e.g., mobile)
  - Mobile phones
- ❖ satellite
  - End-to-end delay of 270ms => It's a problem!
  - Satellite TV
  - Internet: submarine cables preferred





# Network Structure:

## Access Networks: Broadband Networks

- Fixed access networks:
  - Digital subscriber lines over telephone copper pairs (ADSL and VDSL)
- Wired:
  - Hybrid Fiber and Coaxial (HFC) Solutions
  - Fiber Optics to the Home (FTTH)
- Wireless:
  - $\geq 2\text{Mbps}$
  - $\geq 30\text{Mbps}$
- Mobile access networks:
  - 3.5G Networks (UMTS with HSPA)
  - 4G (LTE) networks
  - [5G Networks]

Note: Fast ( $\geq 30\text{ Mbps}$ ) and ultra-fast ( $\geq 100\text{ Mbps}$ ) broadband networks.

# Network structure:

## Home access networks

2

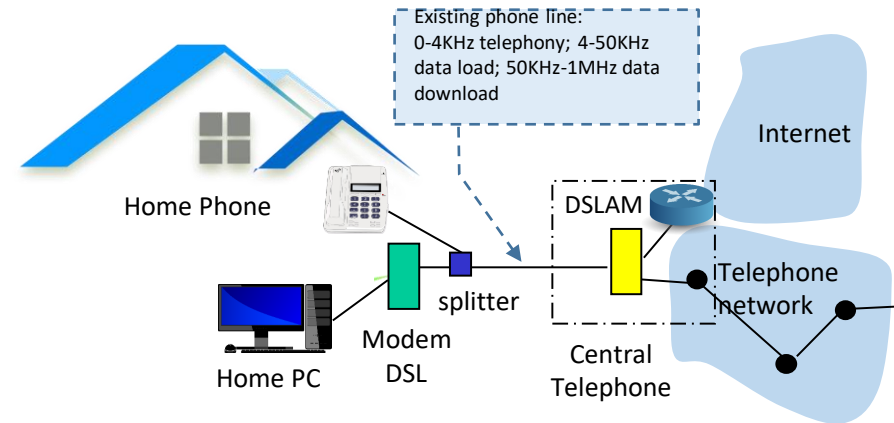
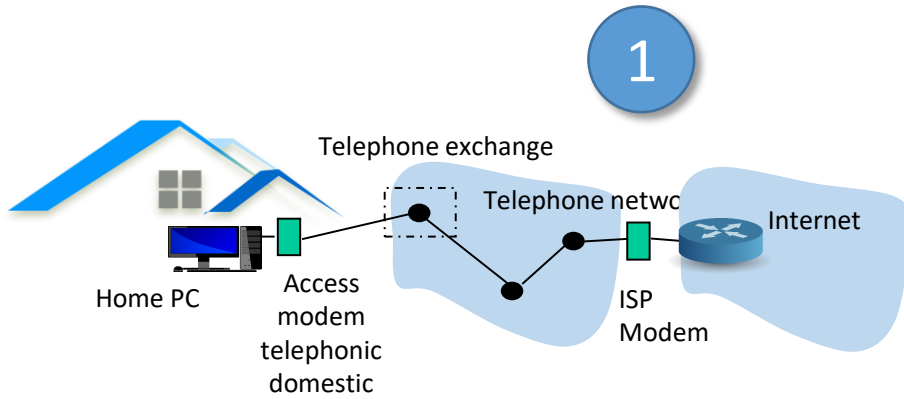

3

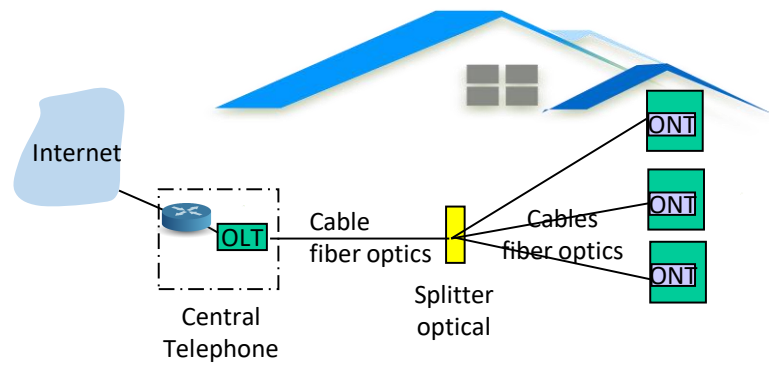

ONT: Optical Network Terminator  
OLT: Optical Line Terminator

# Network Structure: Institutional access networks

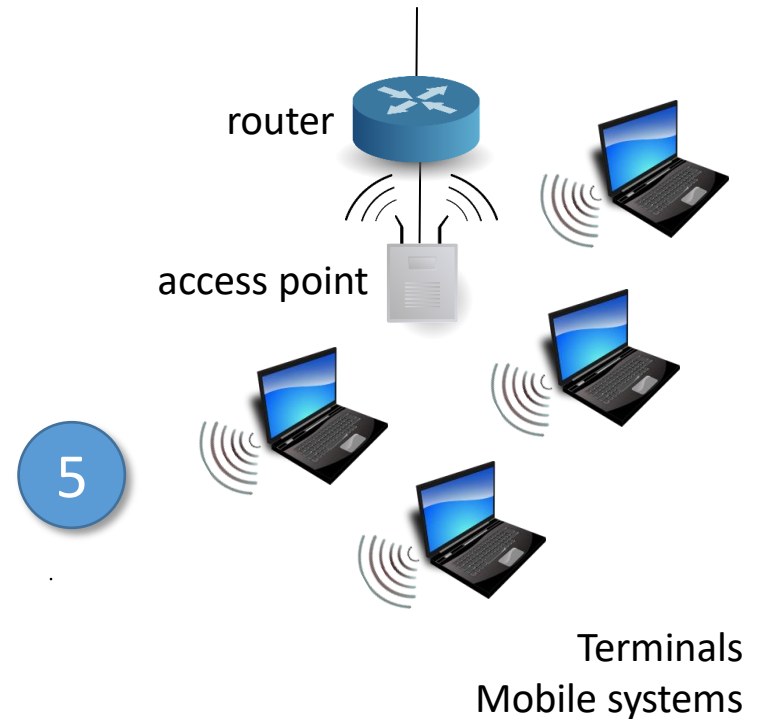
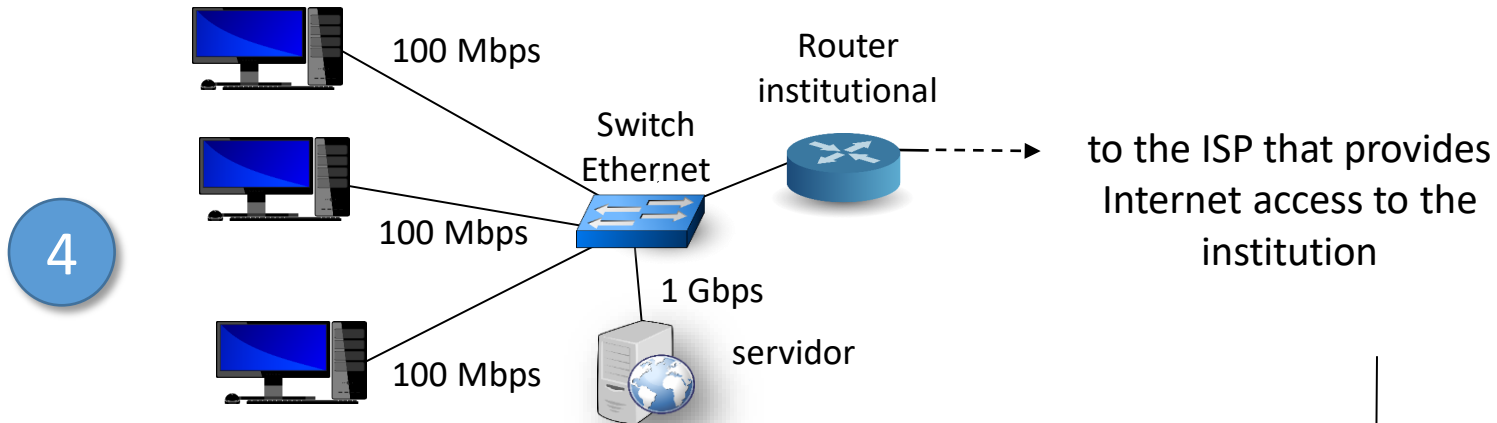

# Network Structure:

## Typical Components in a Home Access Network

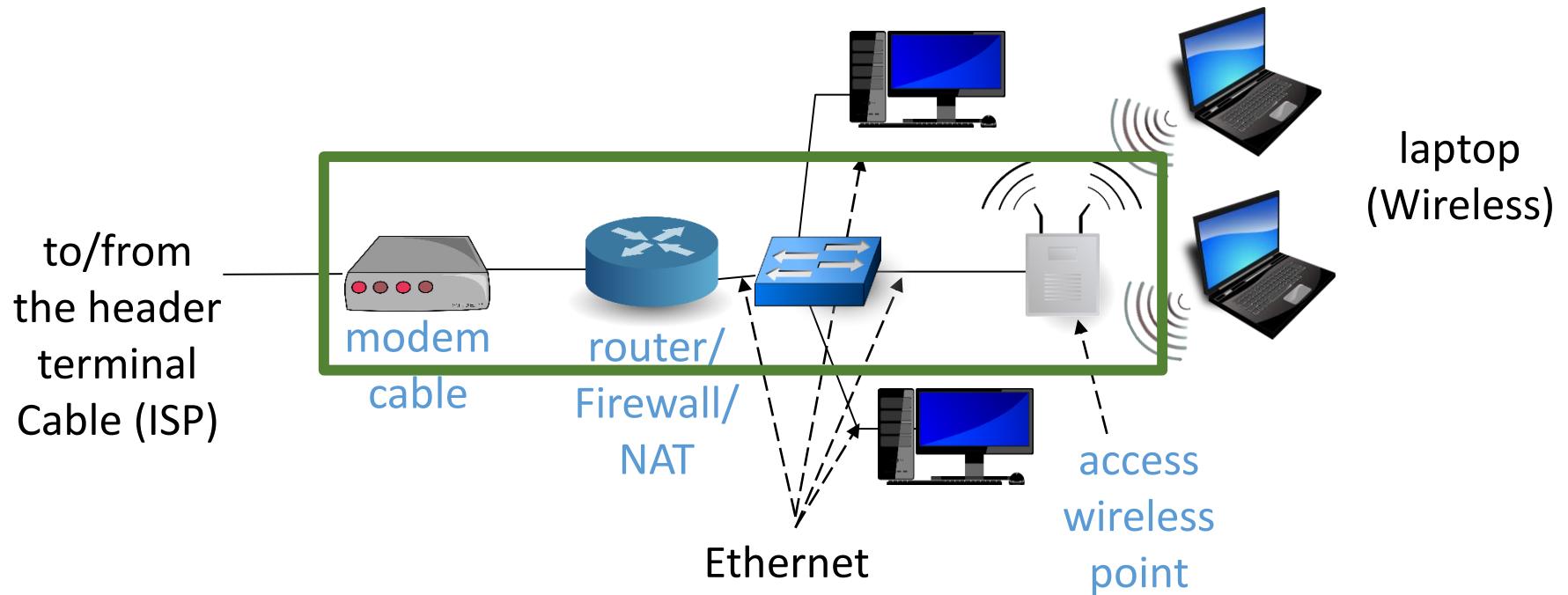

SOHO (*Small Office, home Office*)

# Lesson 1: Computer networks and Internet

## Objectives

- Contact and terminology
- Greater depth, details later in the course
- Focus: Use the Internet as an example

## Content

1. What is the Internet?
2. What is a protocol?
3. The network frontier: computers, access networks, physical media
4. **The core of the network: packet/circuit switching, Internet architecture**
5. Performance: losses, delays, transfer rate
6. Protocol layers, service models

# The core of the network

Mesh of interconnected routers.

How is data transferred over the network?

- **Circuit switching:** dedicated circuit by call (telephone network)
- **Packet switching:** data is sent over the network in smaller chunks (packets)

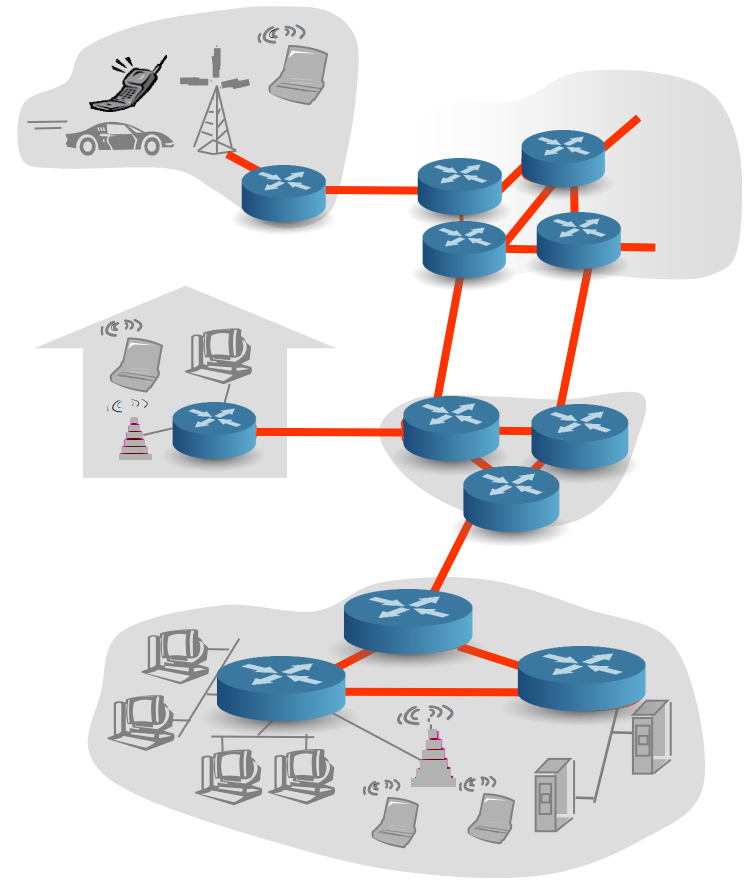



# The core of the network

Mesh of interconnected routers.  
How is data transferred over the network?

**Circuit switching:** dedicated circuit by call (telephone network)

- End-to-end resources reserved by "call"
- Link bandwidth, router capacity
- Dedicated resources: not shared
- Guaranteed performance
- Required connection establishment
- Network resources (e.g., bandwidth) divided into "parts"
  - Parts assigned to calls
  - Part of the resource unused if it is not used by the caller (not shared)
- Dividing link bandwidth into "parts"
  - Frequency division
  - Time division

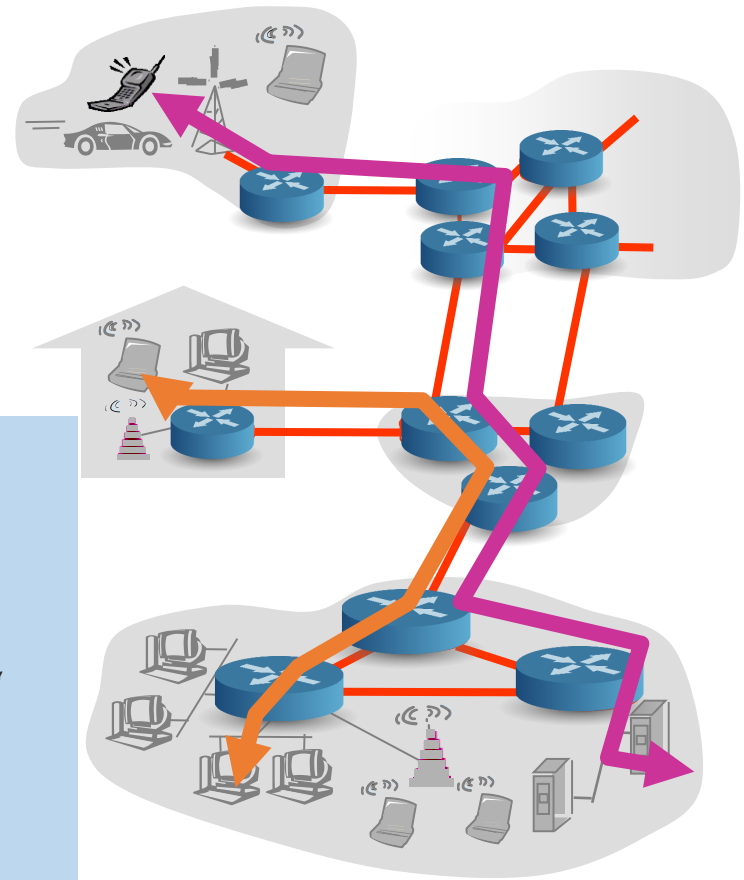

# The core of the network

## Circuit Switching: Examples of Media Access

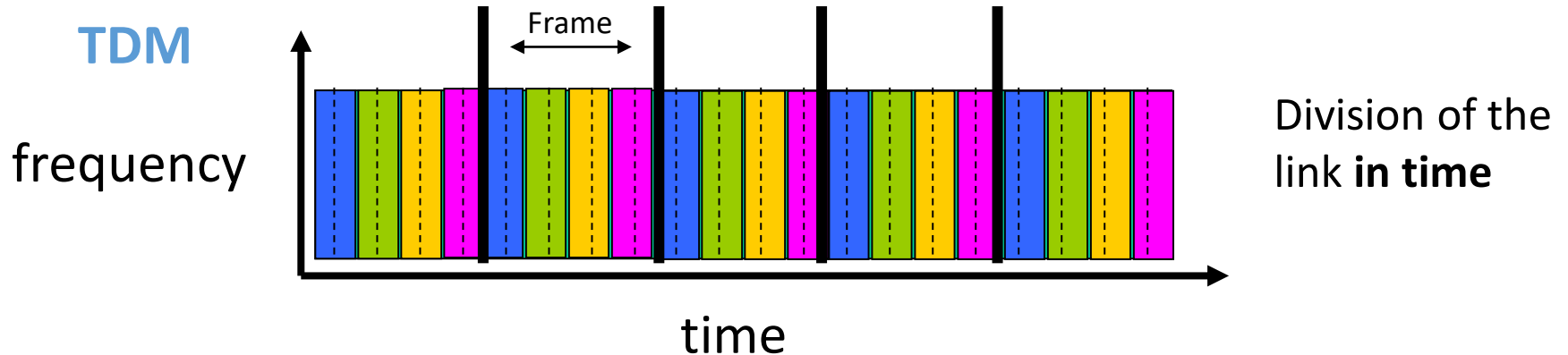
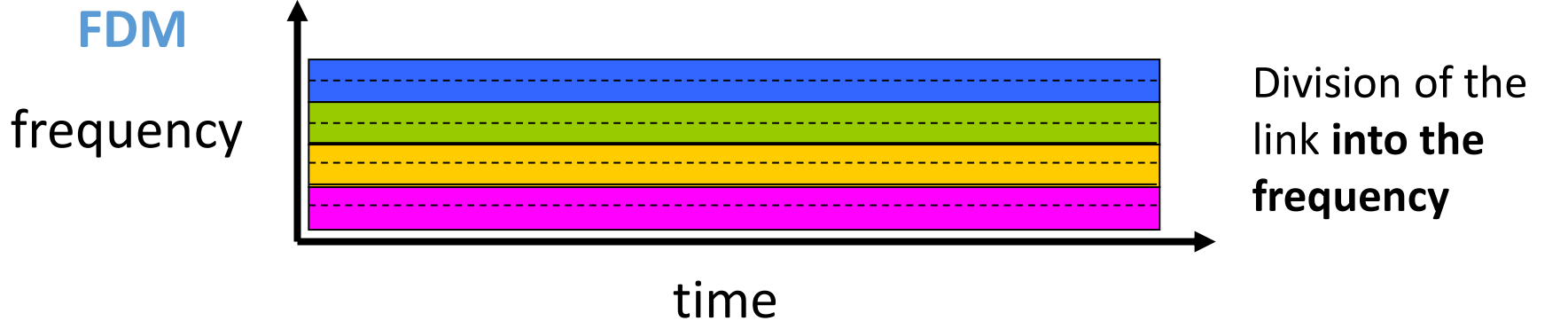

# Core of the network

## Each end-to-end data stream is divided into packets:

- packets from different users share network resources
- Each packet uses the bandwidth of the full link
- Resources are used as needed, there is no reserve of resources

## Contest for resources:

- The resource demand of the set may exceed the amount available -> congestion (waiting for link use -> packet queues)
- Propagation via store and forward: packets advance one step at a time and the node fully receives the packet before forwarding

- **Packet switching:** data is sent over the network in smaller chunks (packets)

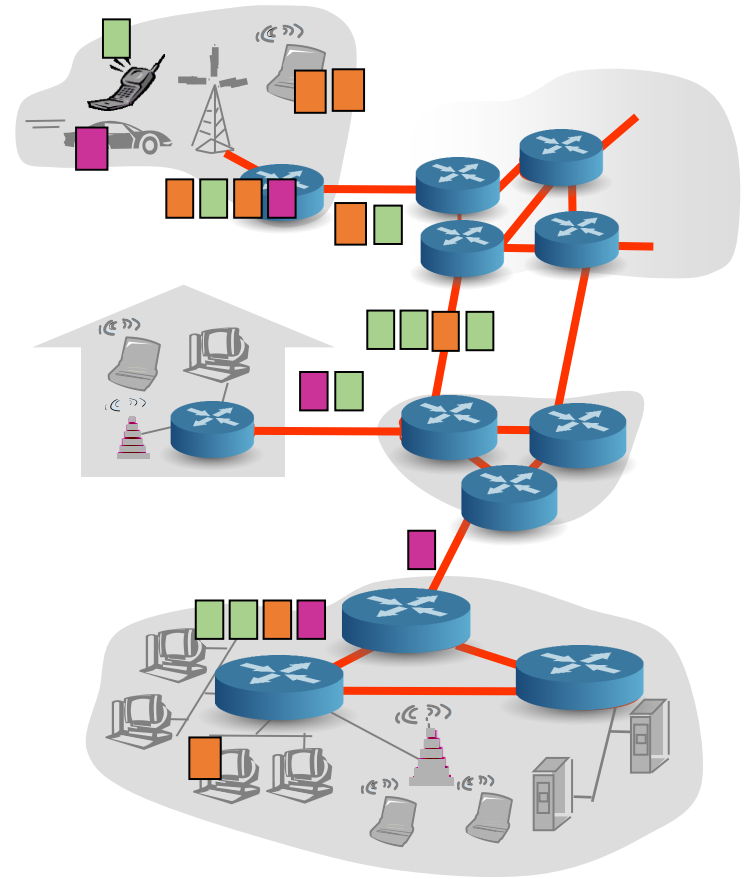

# The core of the network

## Packet Switching: Example of Media Access

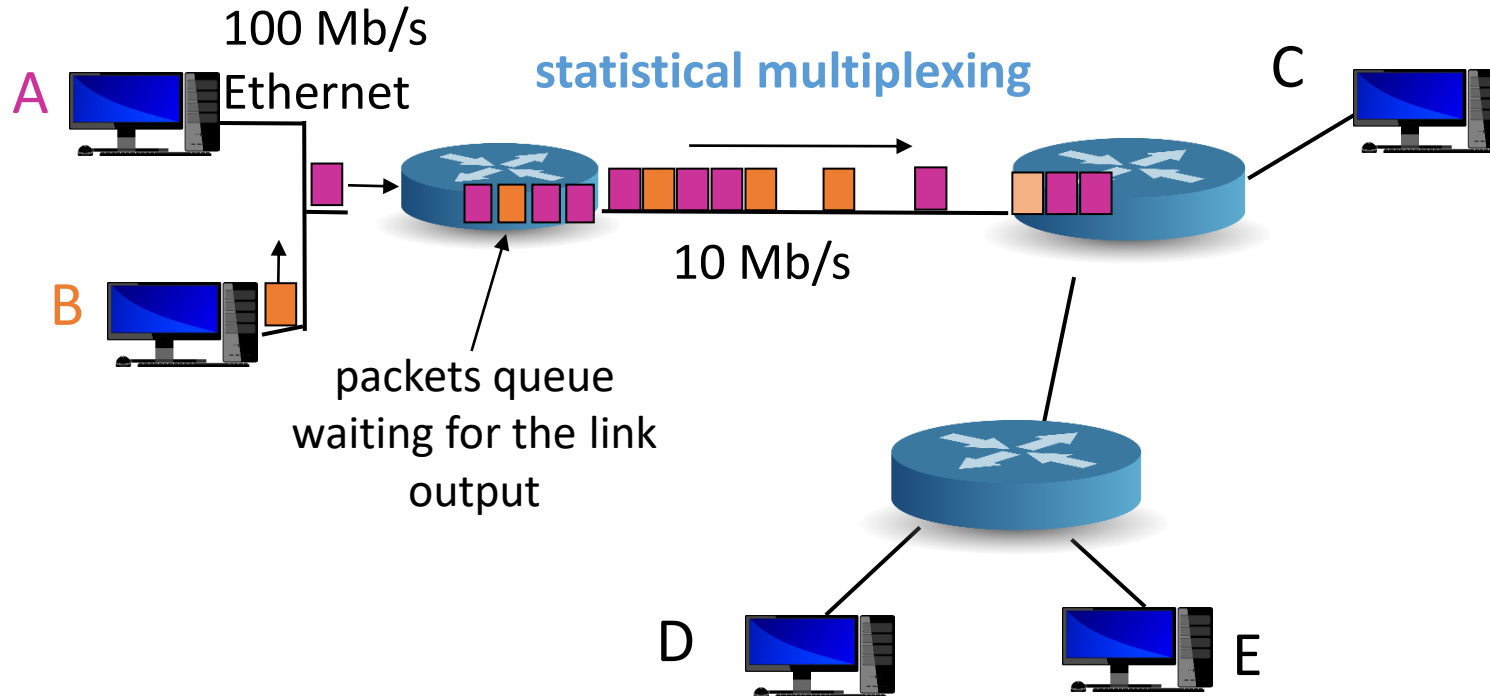

- the packet sequence of a and b has no fixed time pattern
  - Bandwidth is shared on demand: statistical multiplexing

# The core of the network

## Packet Switching: Store-and-Forward Propagation

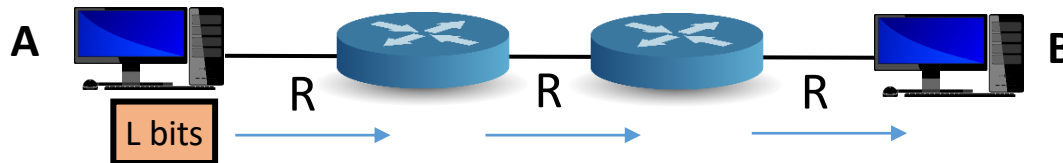

- It takes  $L/R$  seconds to transmit  $L$ -bit packets over an  $R$  bps link
- Store and forward: the entire package must reach the router before being transmitted to the following link
- Delay from node A to node B is  $3L/R$  (assuming zero propagation delay)

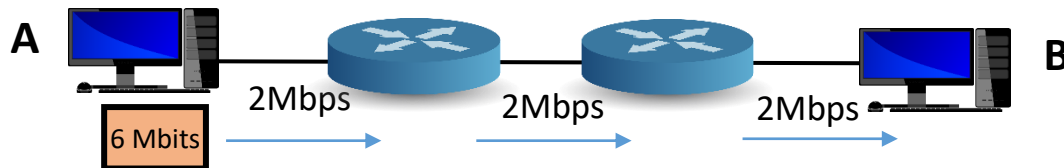

# The core of the network

## Packet vs. circuit switching

Packet switching allows more users to use the network.

Example:

- 1Mbps link
- Each user:
  - 100Kbps when "active"
  - Active 10% of the time
- Circuit switching:
  - 10 users
- Packet switching:
  - with 35 users, probability  $> 10$  active in the same time is less than 0.0004

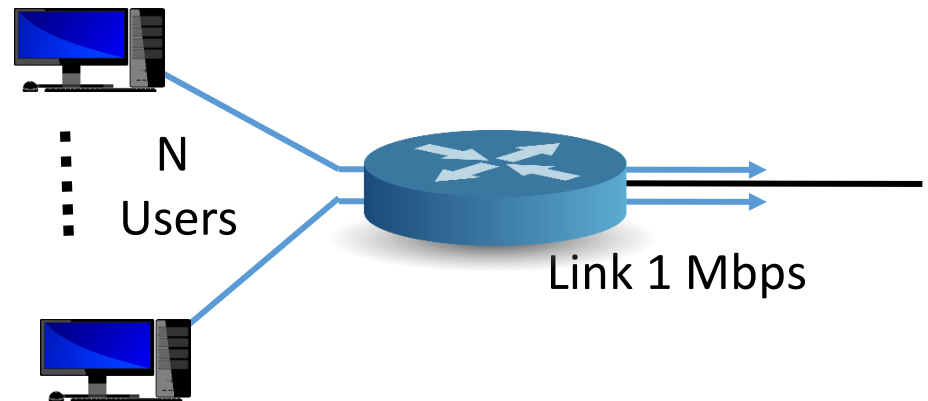

Q: What happens if  $> 35$  users?

# Lesson 1: Computer networks and Internet

## Objectives

- Contact and terminology
- Greater depth, details later in the course
- Focus: Use the Internet as an example

## Content

1. What is the Internet?
2. What is a protocol?
3. The network frontier: computers, access networks, physical media
4. The core of the network: packet/circuit switching, Internet architecture
5. **Performance: losses, delays, transfer rate**
6. Protocol layers, service models





# Performance

## Four sources of delays

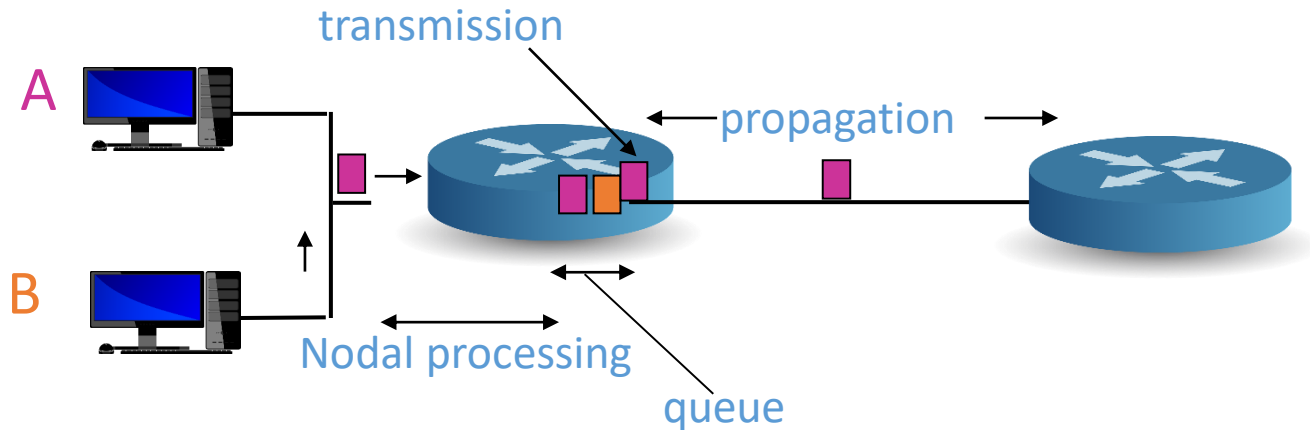

$$d_{\text{nodal}} = d_{\text{proc}} + d_{\text{queue}} + d_{\text{trans}} + d_{\text{prop}}$$

### $d_{\text{proc}}$ : nodal processing

Check for bit-level errors

- Determine the output link
- Typically  $< \mu\text{s}$

### $d_{\text{queue}}$ : queue delay

Timeout before being transmitted by the output link

- Depends on the level of congestion of the router
- Typically  $\mu\text{s}$  or  $\text{ms}$

# Performance

## Four sources of delays

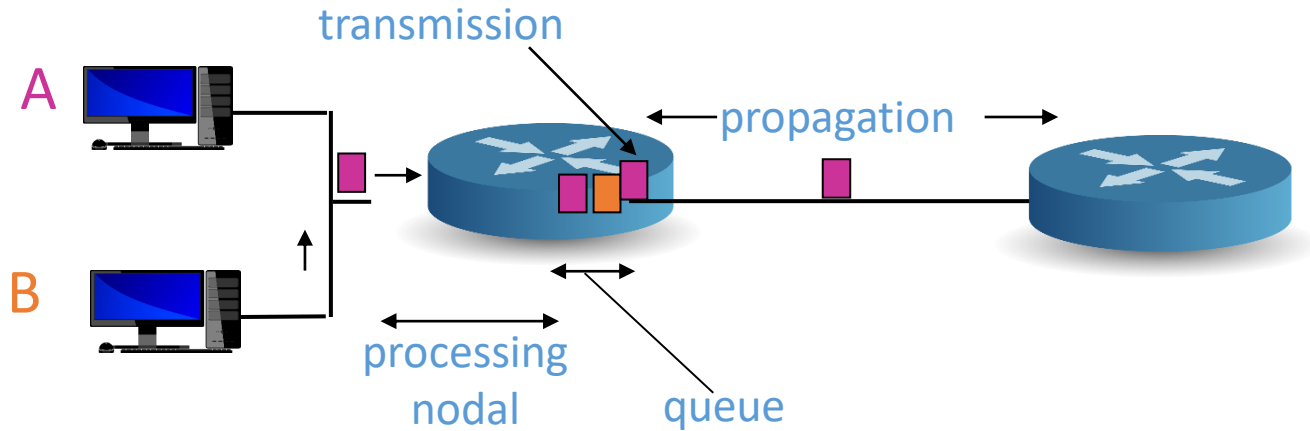

$$d_{\text{nodal}} = d_{\text{proc}} + d_{\text{queue}} + d_{\text{trans}} + d_{\text{prop}}$$

**$d_{\text{trans}}$ : transmission delay**

L: packet length (bits)

R: link bandwidth (bps)

$$d_{\text{trans}} = L/R \text{ (}\mu\text{s o ms)}$$

**$d_{\text{prop}}$ : propagation delay**

d: physical link length

• s: media propagation speed  
( $\sim 2 \times 10^8$  m/s)

$$d_{\text{prop}} = d/s$$

$d_{\text{trans}}$  y  $d_{\text{prop}}$   
Very different

# Performance

## Queue delay

- A: Link bandwidth (bps)
- L: Packet length (bits)
- a: average package arrival rate (packets per second)
- $L \cdot a / R \sim 0$ : Small average queue delay
- $L \cdot a / R < 1$ : large average queue delay
- $L \cdot a / R > 1$ : more packets arrive than can be served, infinite queue delay!

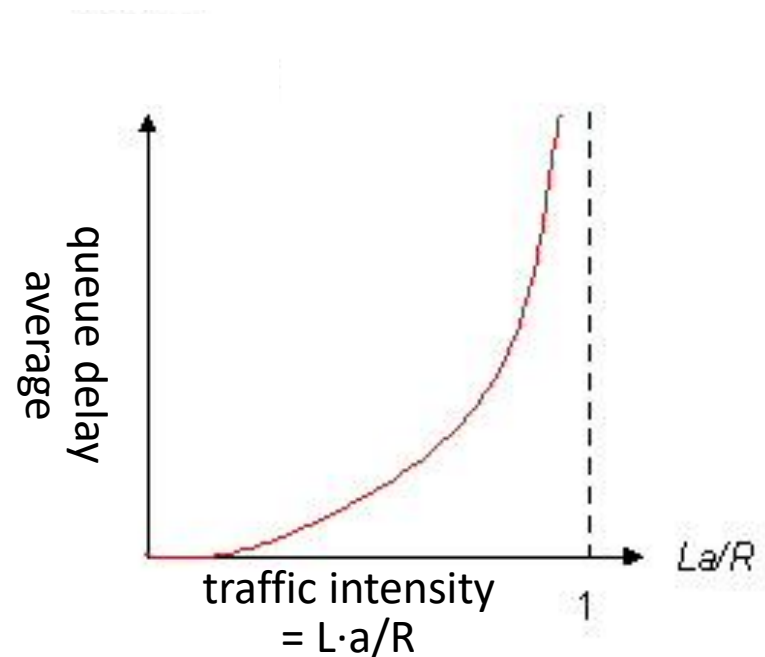

$L \cdot a / R \sim 0$



$L \cdot a / R \rightarrow 1$

# Performance

## Packet loss

- The buffer associated with a link has a finite capacity
- Packages that arrive in a full queue are dropped (lost)
- Discarded packets can be retransmitted by the source terminal system, by the previous node or by no one

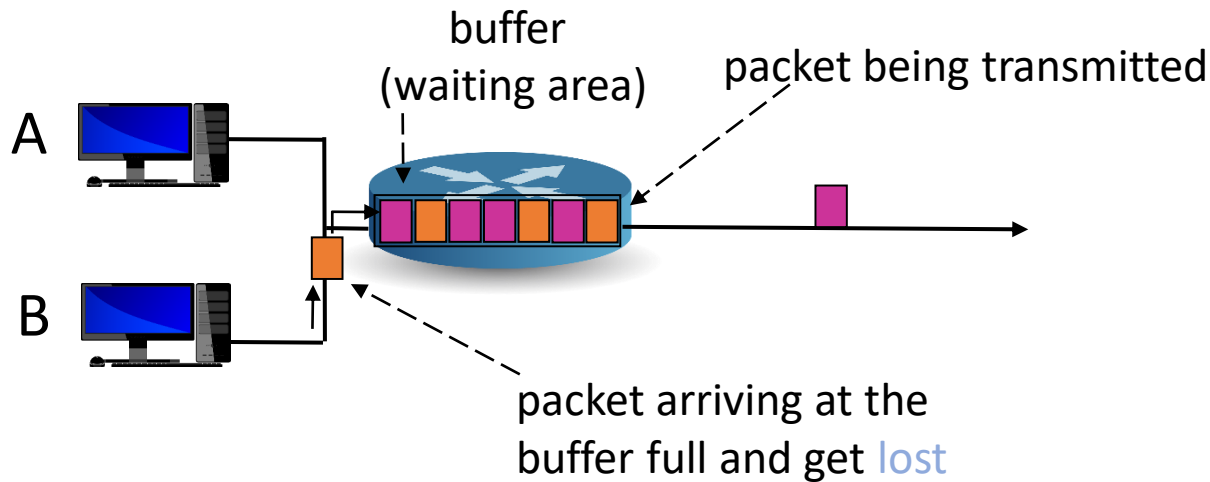

# Performance

## Transfer rate (end-to-end)

Throughput: rate (bits/unit of time) at which bits are transferred between client and server

- Instantaneous: rate in a given instant of time
- Average: rate measured over a period of time

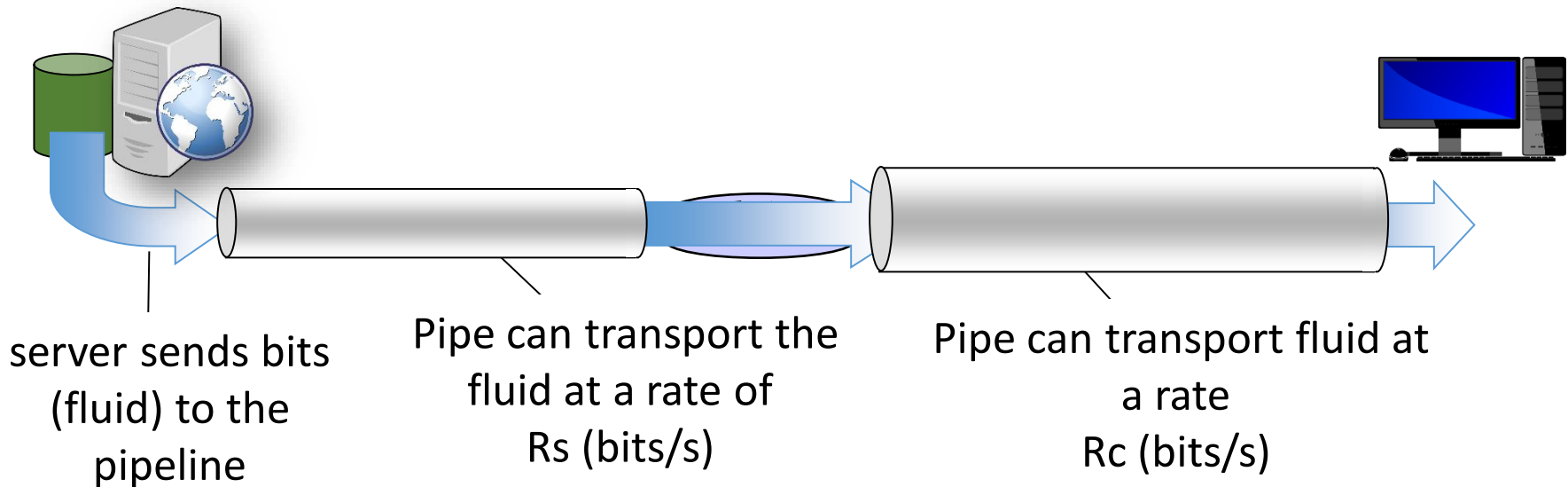

# Performance

## Transfer rate (end-to-end)

If  $R_s < R_c$ , average terminal-to-terminal transfer rate?

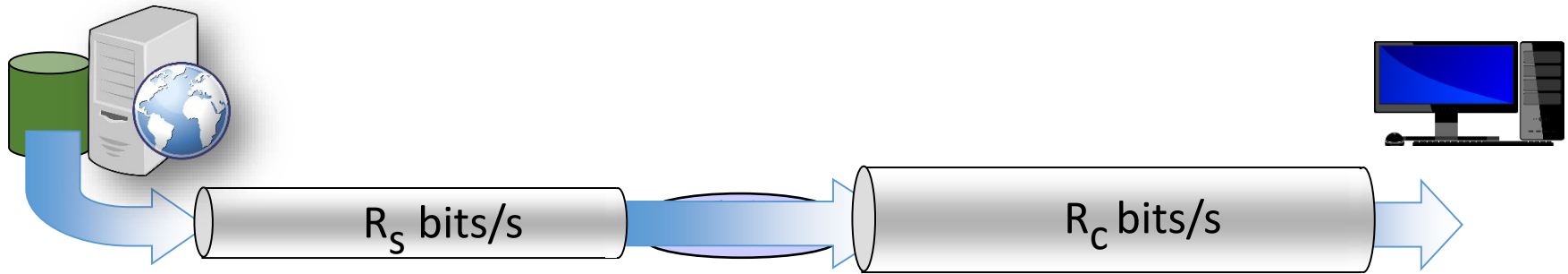

If  $R_s > R_c$ , average terminal-to-terminal transfer rate?

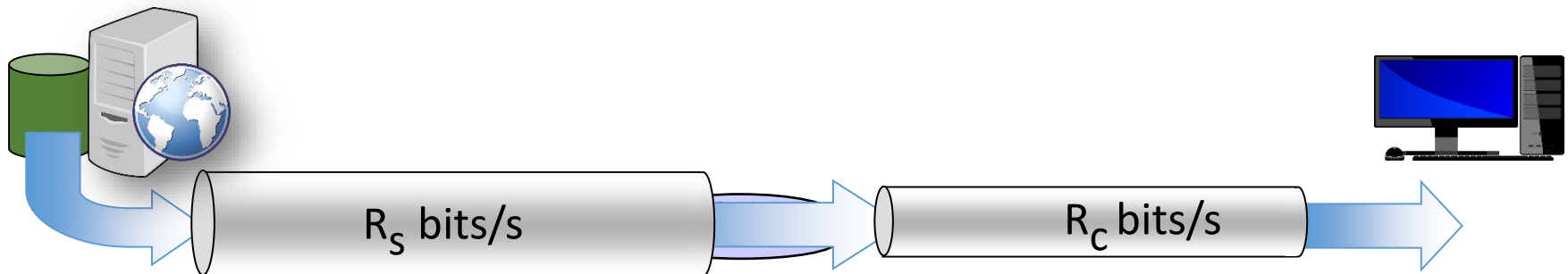

# Performance

## Transfer rate (end-to-end)

If  $R_s < R_c$ , average terminal-to-terminal transfer rate?

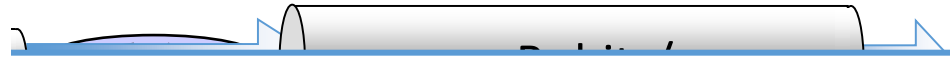
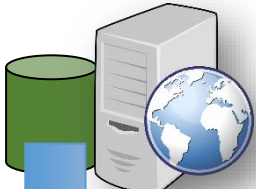

*bottleneck link*

It is the link in the end-to-end path that limits the end-to-end transfer rate.

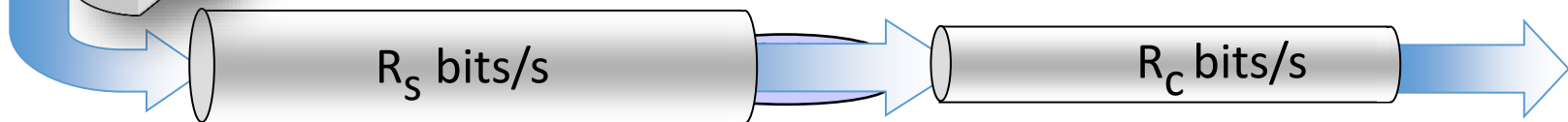

# Performance

## Transfer Rate: Internet Scenario

- Terminal-to-terminal transfer rate per connection:  
 $\min(R_c, R_s, R/10)$
- In practice:  $R_c$  or  $R_s$  is often the bottleneck

The transfer rate depends not only on the transmission speeds of the links but also on the existing traffic. Even if the transmission speed of the link is high, it can be the bottleneck if there is a lot of data flow going through that link.

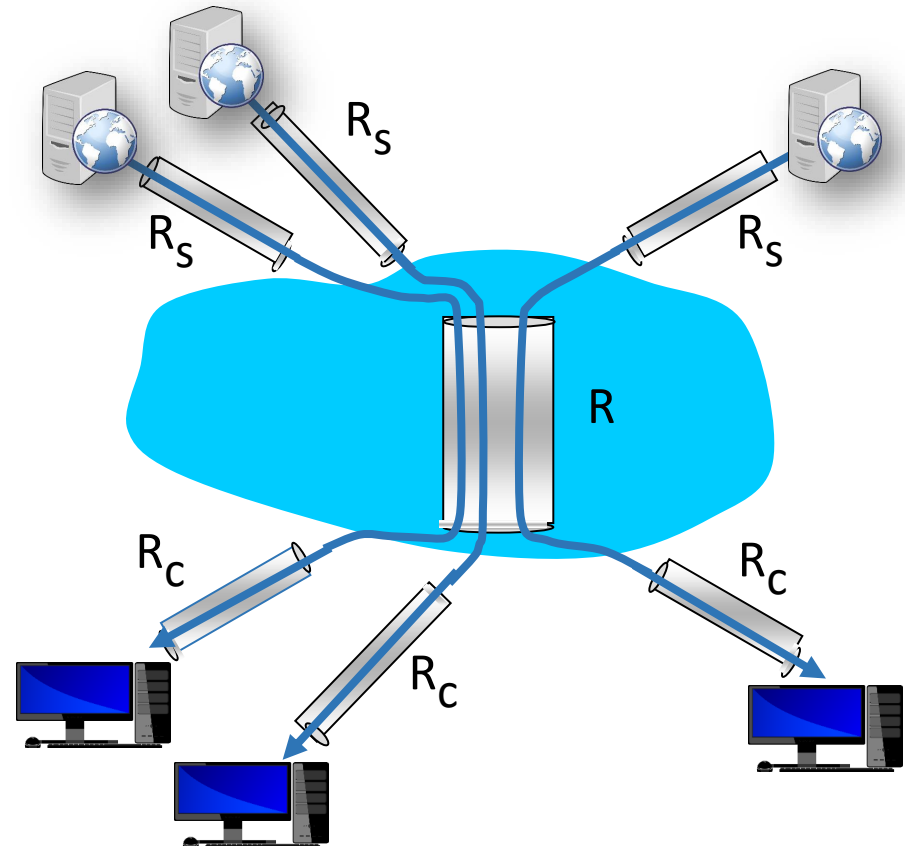

10 connections share the common link (in equal parts) with  $R$  bit/s rate



# Lesson 1: Computer networks and Internet

## Objectives

- Contact and terminology
- Greater depth, details later in the course
- Focus: Use the Internet as an example

## Content

1. What is the Internet?
2. What is a protocol?
3. The network frontier: computers, access networks, physical media
4. The core of the network: packet/circuit switching, Internet architecture
5. Performance: losses, delays, transfer rate
6. **Protocol layers, service models**

# Protocol layers, service models

Networks are complex, with many "pieces":

- Terminal systems
- Routers
- Multi-media links
- Applications
- Protocols
- Software
- Hardware

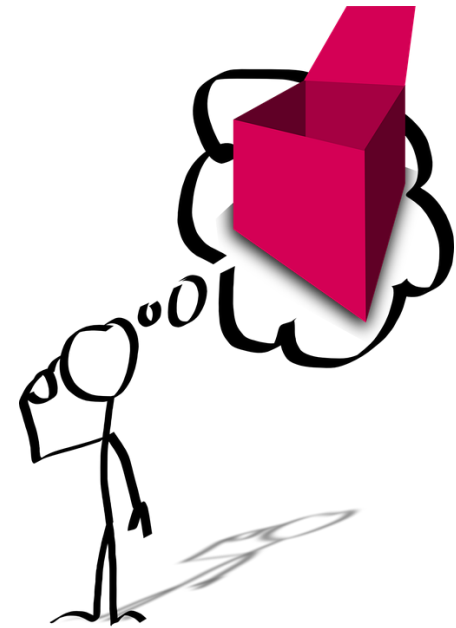

Do we have any hope of being able to organize a network architecture?

# Protocol layers, service models

Simile with the organization of a plane trip

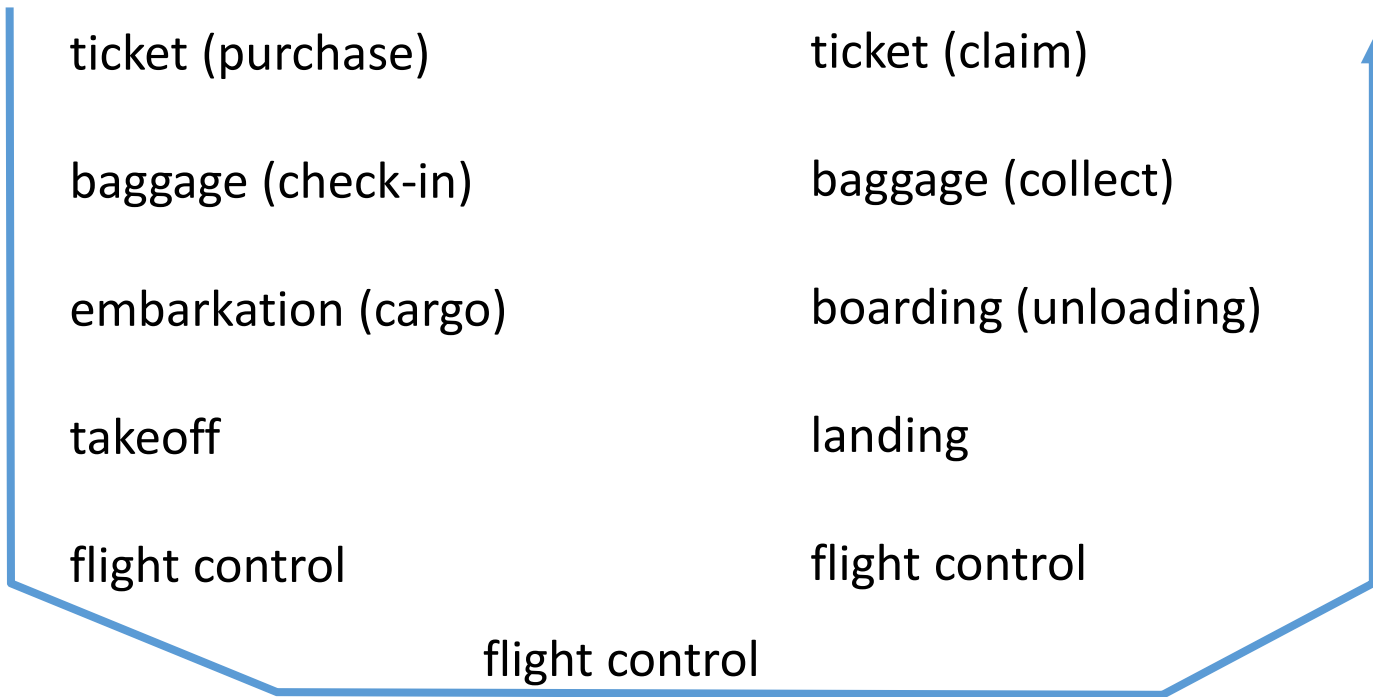

A set of steps...

# Protocol layers, service models

## Simile with the organization of a plane trip

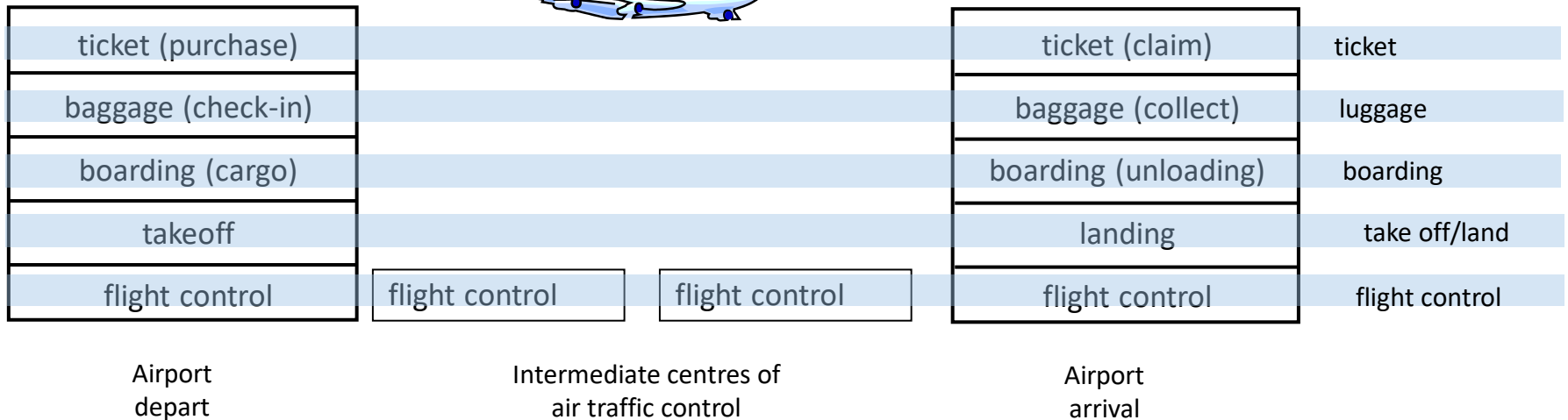
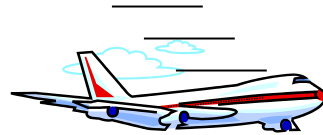

**Layers or levels:** each layer implements a service...

- performing certain actions within that layer
- using the services provided by the layer you have directly below it

# Protocol layers, service models

## Why a layered architecture?

Systems are complex:

- A specific structure makes it possible to identify and relate the complex parts of the system
- A **layered reference** model for analysis and discussion
- Modularization simplifies system maintenance and upgrade
- Modifying the service implementation of a layer is transparent to the rest of the system
- E.g., change in boarding procedure does not affect the rest of the system

# Protocol layers, service models

## How do you organize a layered architecture?

- At each end there must be an instance of a certain level, known as an **entity**.
- Each level performs a set of tasks, known as **functions**
- Not all functions are performed at each end of the communication.
- E.g., in the baggage layer there is the check-in function and the collect function.
- Each level offers a set of features (provider) at the top level (user), known as **services**
- E.g., the check-in service.
- Access to services at a certain level is done through an interface known as SAP (Service Access Point).

# Protocol layers, service models

## How do you organize a layered architecture?

- At each level, a certain protocol is used to communicate with another entity of the same level, offer services to its higher level and perform the functions entrusted to it.

- Use the services offered by the lower level.

The protocol describes:

- the format of the messages to be exchanged PDU (Protocol Data Unit)
- message exchange rules

Example

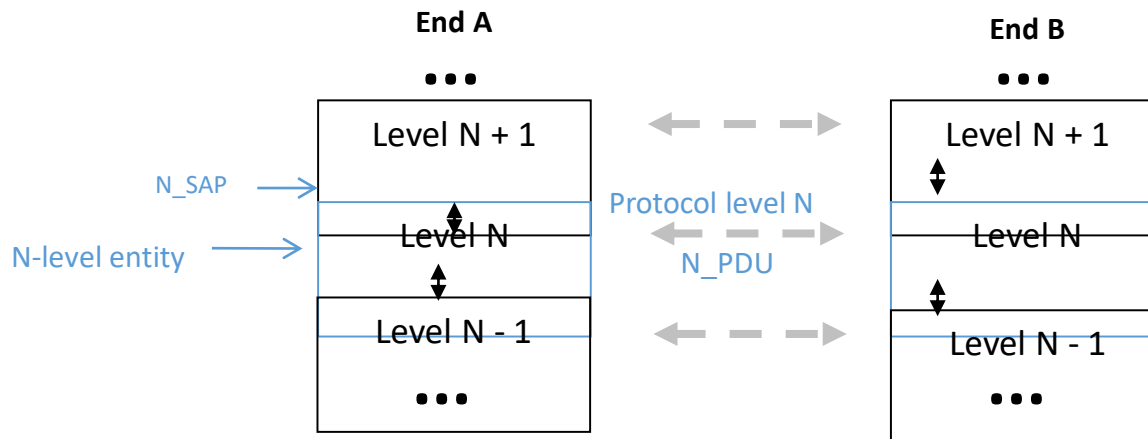

### Note

One level can offer different services. Each will use its own protocol

# Protocol layers, service models

## Layered architecture

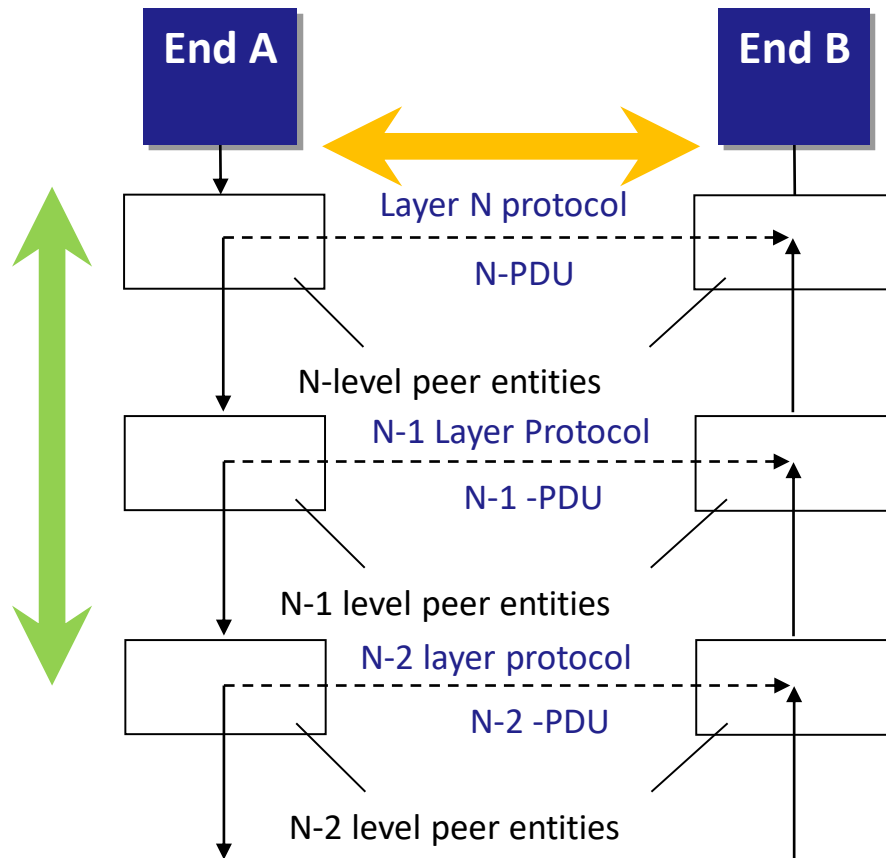

What is the flow of information?

### Real:

- Between adjacent levels.
- Through SAP.
- Vertical communication.
- PDUs have to be encapsulated and deencapsulated.
- On the same computer.

### Logic:

- Between peer entities.
- Horizontal communication
- Between different teams.
- PDUs are exchanged.

### Note

Entities at the same level are known as peer entities



# Protocol layers, service models

## Encapsulation

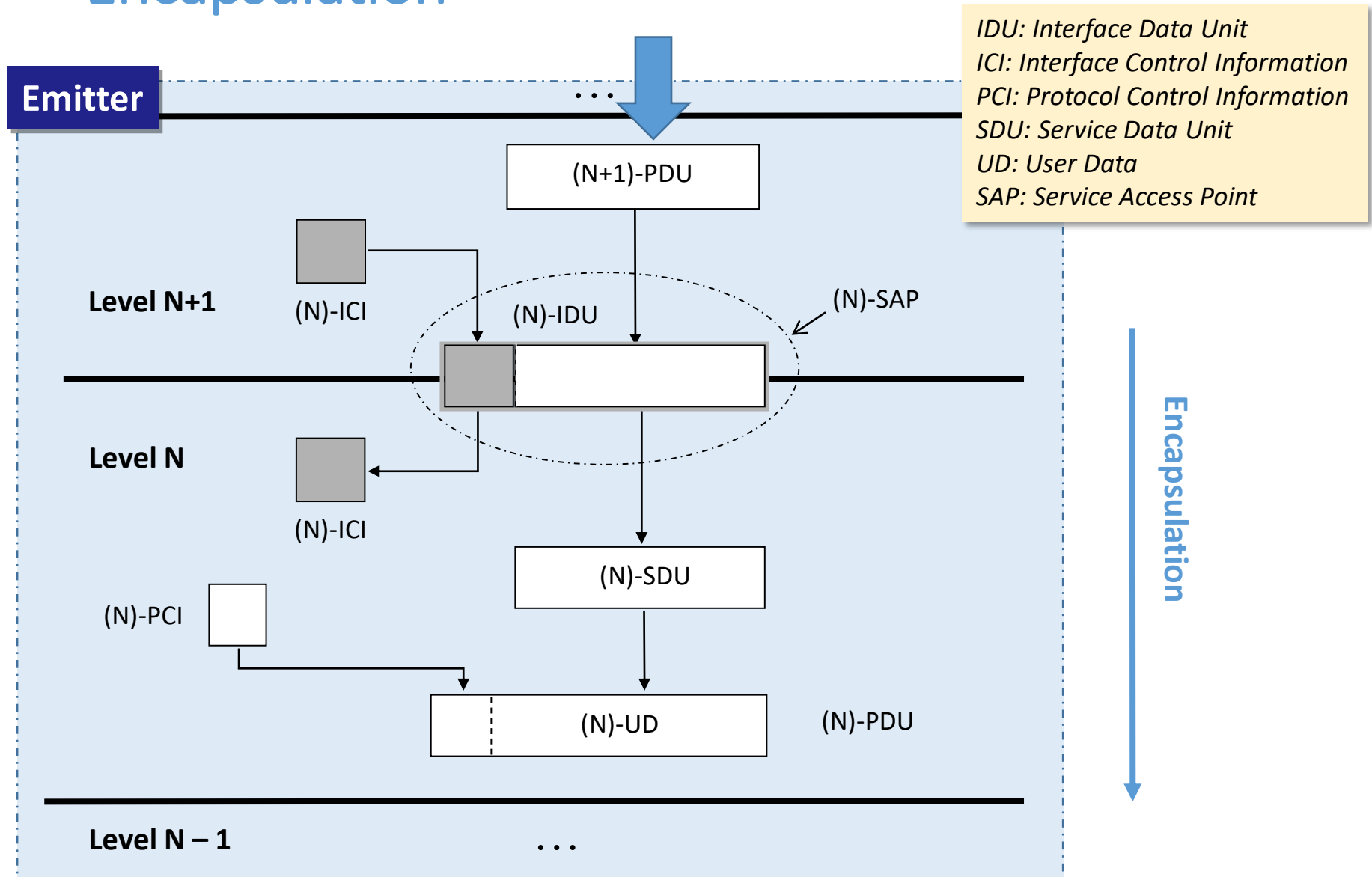

# Protocol layers, service models

## Deencapsulation

*IDU: Interface Data Unit*  
*ICI: Interface Control Information*  
*PCI: Protocol Control Information*  
*SDU: Service Data Unit*  
*UD: User Data*  
*SAP: Service Access Point*

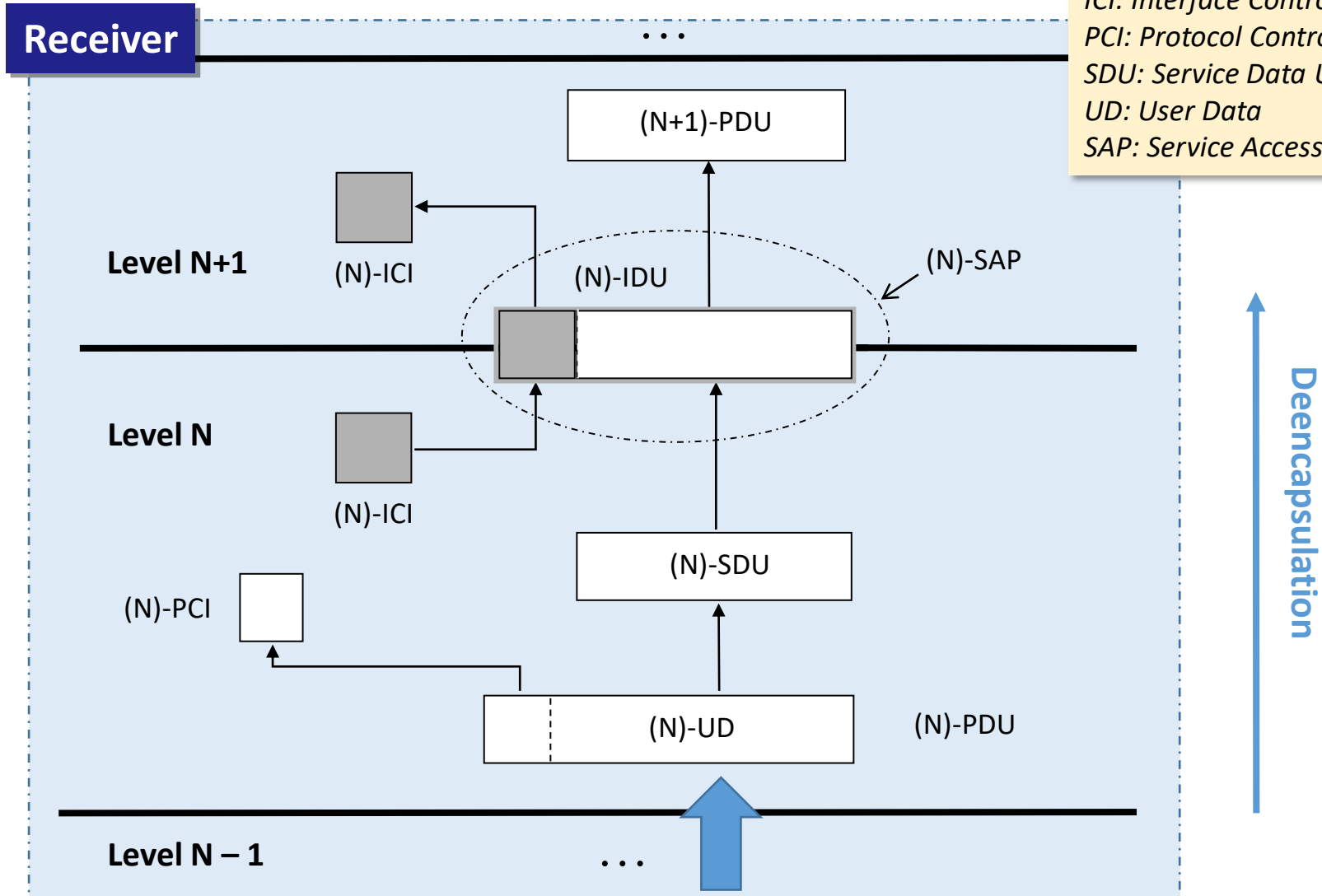

# Protocol layers, service models

## Fragmentation

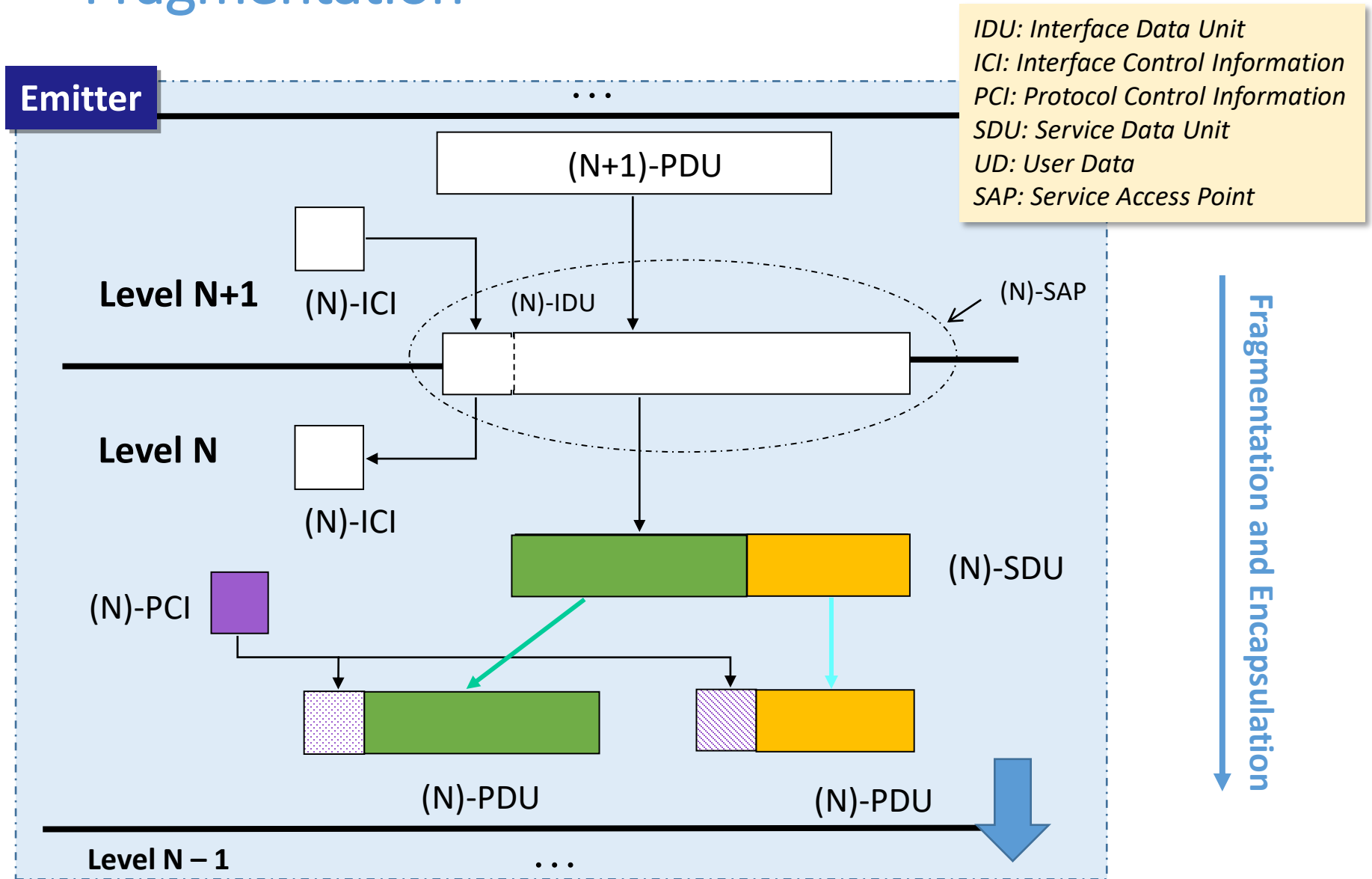

# Protocol layers, service models

## Reassembly

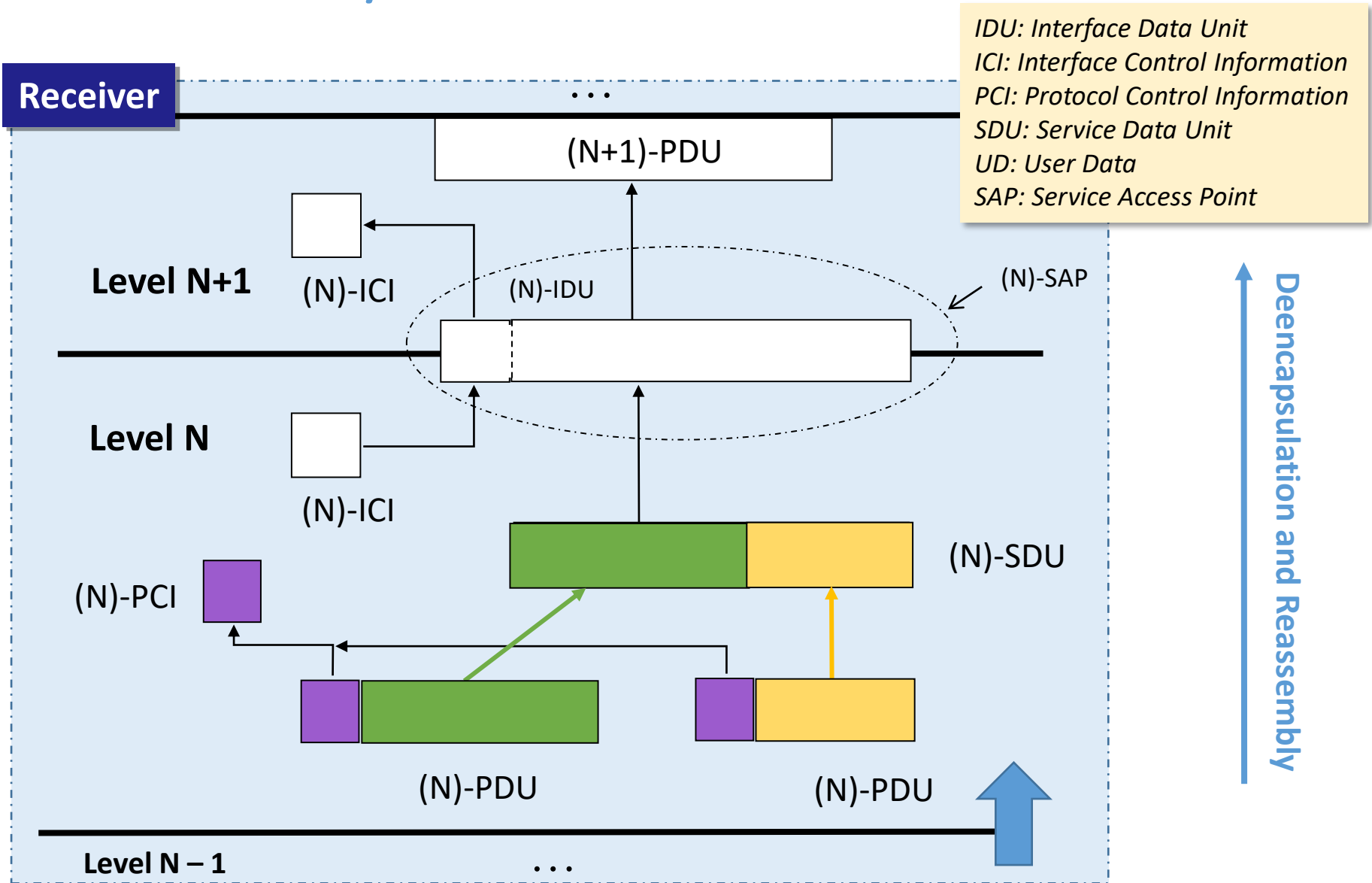

# Protocol layers, service models

## How many layers are needed?

- Depends on the set of functions that you want your network architecture to have.
- Two network architectures:
  - **TCP/IP**
    - It is the one used on the Internet.
    - It consists of five layers.
    - Describes functions, services, and protocols
  - **Reference model OSI (Open System Interconnection).**
    - It consists of seven layers.
    - ISO (International Organization for Standardization) standard.
    - Describes roles and services.

# Protocol layers, service models

## Internet Protocol Stack

- **Application:** Supports network applications. Serves as an interface with the end user
  - FTP, SMTP, HTTP, DNS
- **Transport:** end-to-end data transfer between processes
  - TCP, UDP
- **Internet or Network:** addressing and routing datagrams from source to destination
  - IP, protocolos de rutado
- **Link:** Data transfer among "nearby" network elements
- **Physical:** bits "on the wire"
  - Ethernet (conectores y cables)

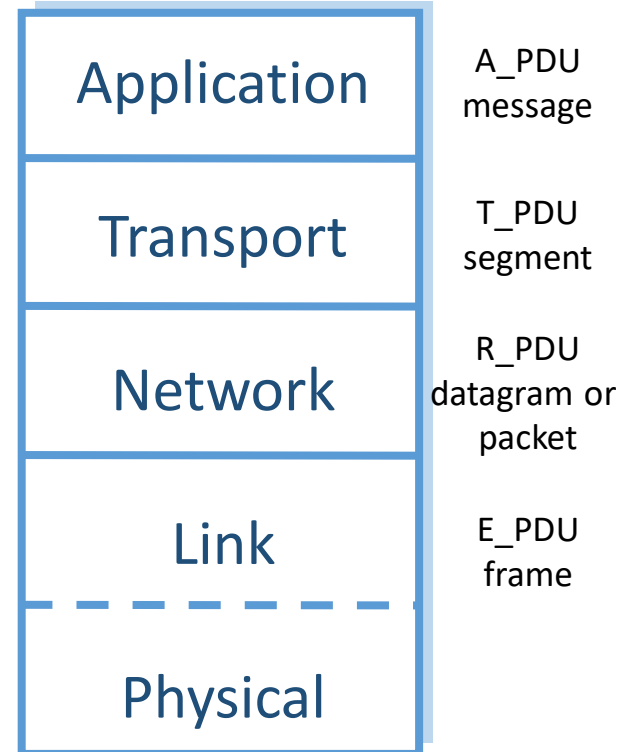

# Protocol layers, service models

## Reference model ISO/OSI

- **Presentation**: allows applications to interpret the meaning of data, e.g. encryption, compression, encodes data in standard mode
- **Session**: synchronization, checkpoints, data exchange recovery
- The Internet stack "skips" these layers...
  - If these services are necessary, they must be implemented in application
  - Are they necessary?

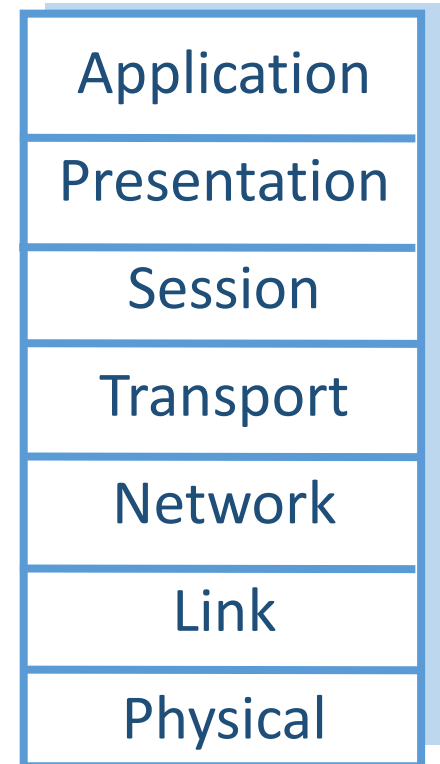

# Protocol layers, service models

## How are layers implemented?

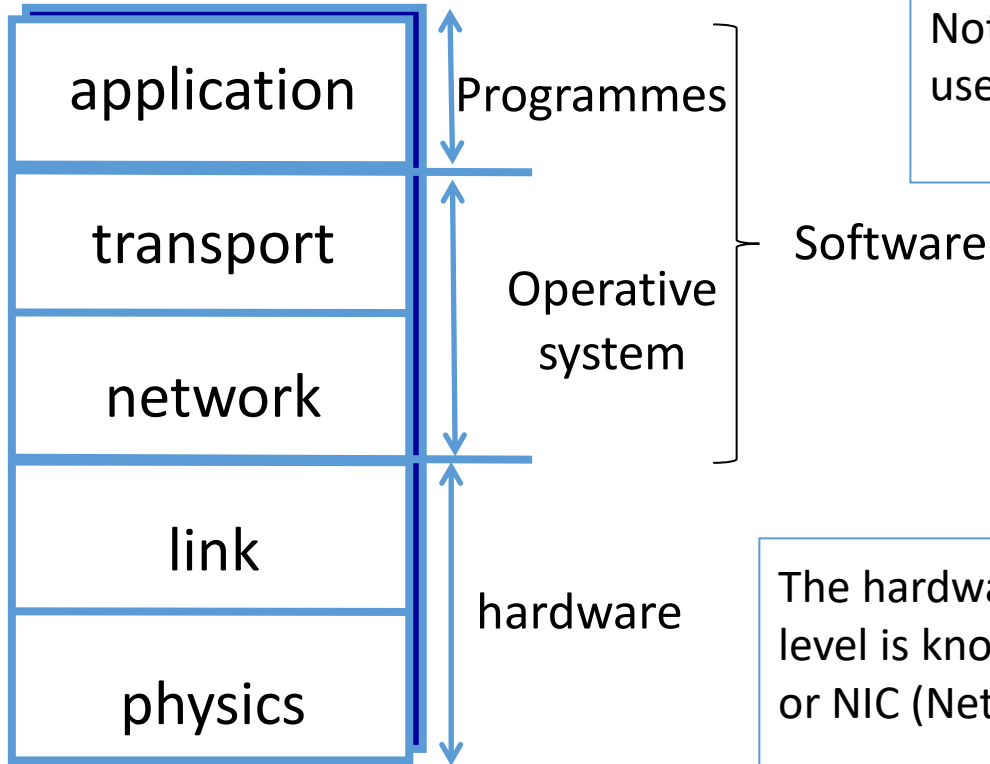

### Note

Not all levels are on all devices that are used on the Internet.

### Note

The hardware that implements the link and physical level is known as a network interface, network card or NIC (Network Interface Card).





# Protocol layers, service models

Example of two end systems interconnected by a router

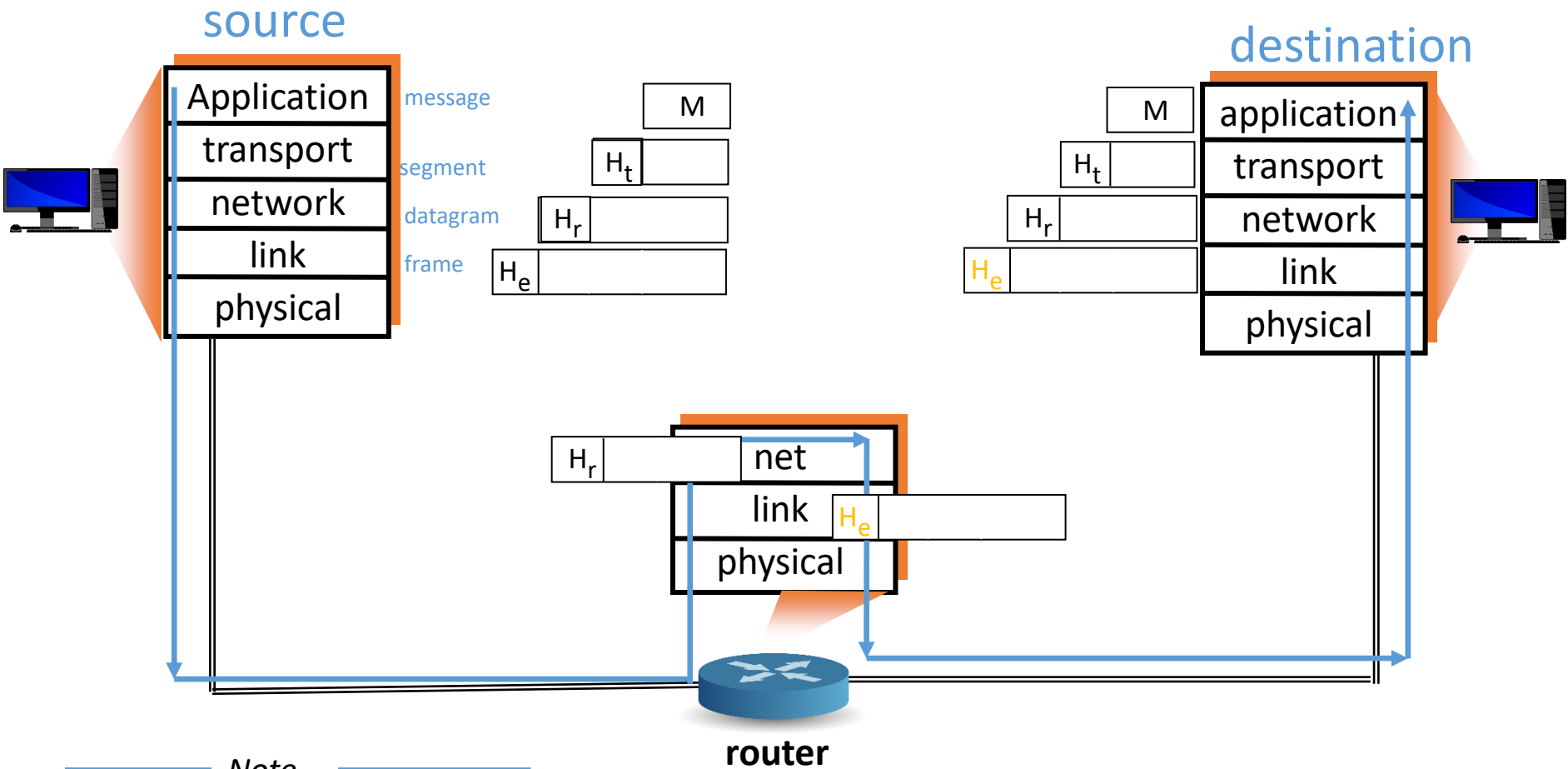

**Note**

$H_x = X\_PCI$

$M = A\_PCI(H_a) + \text{User Data (UD)}$

**UD Example:**

- Subject/body of a e\_mail
- Text of a WhatsApp message

Physical media

# Protocol layers, service models

Example of two end systems interconnected by a router

